

## XZCP1041L2

unaprijed ožičeni konektori XZ – ženski pod kutom –  
M8 – 4 pina – kabel PUR 2 m



### Glavno

Accessory / separate part category	Cabling accessory
Accessory / separate part type	Pre-wired connectors
Series name	General purpose

### Komplementarno

Electrical connection	M8, 4 pins elbowed female connector
Cable connector fixing	Screw-on
Collar material	Metal
Status LED	Without
Cable length	2 m
Cable outer diameter	5.2 mm
Cable composition	4 x 0.34 mm <sup>2</sup>
Wire insulation material	PUR
[Ue] rated operational voltage	60 V AC 75 V DC
[In] rated current	4 A
Contact resistance	5000 μOhm
Insulating resistance	1 GΩ
Product weight	0.08 kg

### Okolina

IP degree of protection	IP65 IP67 IP69K
product certifications	CULus
ambient air temperature for operation	-40...80 °C (static) -5...80 °C (flexing)
ambient air temperature for storage	-40...80 °C

### Offer Sustainability

Green Premium product	Green Premium product
Compliant - since 0649 - Schneider Electric declaration of conformity	Compliant - since 0649 - Schneider Electric declaration of conformity
Reference not containing SVHC above the threshold	Reference not containing SVHC above the threshold
Available	Available
Available	Available

### Contractual warranty

Warranty period	18 months
-----------------	-----------

Informacije dane u ovoj dokumentaciji sadrže opće opise i/ili tehničke karakteristike o performansama ovdje sadržanih proizvoda.  
Ova dokumentacija nije namijenjena kao zamjena za niti bi se trebala koristiti za određivanje prikladnosti ili pouzdanosti predmetnih proizvoda za konkretne korisničke primjene.  
Svaki takav korisnik ili integrator dužan je provesti odgovarajuću i potpunu analizu rizika, procjenu i ispitivanje proizvoda u odnosu na odgovarajuću specifičnu primjenu ili uporabu istog.  
Niti društvo Schneider Electric Industries SAS niti bilo koje od njegovih povezanih podružnica neće preuzeti obvezu ili snositi odgovornost za pogrešnu upotrebu ovdje sadržanih informacija.

## Dimensions

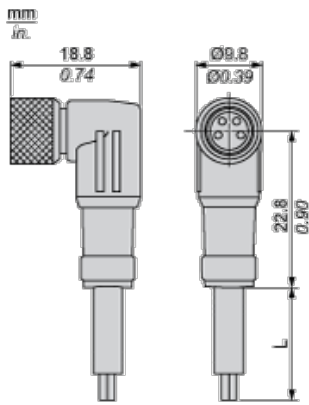

L : Length of cable

## Connections and Schemes

### Connector

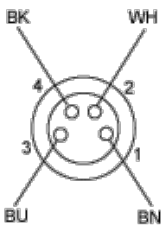

BN : Brown

BK : Black

BU : Blue

WH : White