

XUK0AKSAL2

fotoelektrični senzor – XUK – multi – Sn 0..30 m –
12..24 V DC – kabel od 2 m



Glavno

Range of product	OsiSense XU
Series name	General purpose multimode
Electronic sensor type	Photo-electric sensor
Sensor name	XUK
Sensor design	Compact 50 x 50
Detection system	Multimode
Material	Plastic
Type of output signal	Discrete
Supply circuit type	DC
Wiring technique	3-wire
Discrete output type	PNP or NPN
Discrete output function	1 NO or 1 NC programmable
Electrical connection	Cable
Cable length	2 m
Product specific application	-
Emission	Infrared diffuse Infrared diffuse with background suppression Infrared thru beam Red polarised reflex
[Sn] nominal sensing distance	0.28 m diffuse with background suppression 0.8 m diffuse 4 m polarised reflex need reflector XUZC50 30 m thru beam need a transmitter XUK0AKSAL2T

Komplementarno

Enclosure material	PBT
Lens material	PMMA
Maximum sensing distance	35 m thru beam 0.28 m diffuse with background suppression 1.2 m diffuse 5.7 m polarised reflex
Output type	Solid state
Add on output	With alarm output, <= 50 mA with overload and short-circuit protection
Wire insulation material	PvR
Status LED	1 LED (green) for supply 1 LED (red) for instability 1 LED (yellow) for output state
[Us] rated supply voltage	12...24 V DC with reverse polarity protection
Supply voltage limits	10...36 V DC
Switching capacity in mA	<= 100 mA (overload and short-circuit protection)
Switching frequency	<= 250 Hz
Voltage drop	<= 1.5 V (closed state)
Current consumption	<= 35 mA (no-load)
Delay first up	< 200 ms
Delay response	< 2 ms
Delay recovery	< 2 ms
Setting-up	Self-teaching
Depth	50 mm
Height	50 mm

Informacije dane u ovoj dokumentaciji sadrže opće opise i/ili tehničke karakteristike o performansama ovdje sadržanih proizvoda. Ova dokumentacija nije namijenjena kao zamjena za niti bi se trebala koristiti za određivanje prikladnosti ili pouzdanosti predmetnih proizvoda za konkretne korisničke primjene. Svaki takav korisnik ili integrator dužan je provesti odgovarajuću i potpunu analizu rizika, procjenu i ispitivanje proizvoda u odnosu na odgovarajuću specifičnu primjenu ili uporabu istog. Niti društvo Schneider Electric Industries SAS niti bilo koje od njegovih povezanih poduzeća ili podružnica neće preuzeti obvezu ili snositi odgovornost za pogrešnu upotrebu ovdje sadržanih informacija.

Width	18 mm
Product weight	0.175 kg

Okolina

product certifications	CE CSA UL
ambient air temperature for operation	-25...55 °C
ambient air temperature for storage	-40...70 °C
vibration resistance	7 gn, amplitude = +/- 1.5 mm (f = 10...55 Hz) conforming to IEC 60068-2-6
shock resistance	30 gn (duration = 11 ms) conforming to IEC 60068-2-27
IP degree of protection	IP65 double insulation conforming to IEC 60529

Offer Sustainability

Not Green Premium product	Not Green Premium product
Compliant - since 0903 - Schneider Electric declaration of conformity	Compliant - since 0903 - Schneider Electric declaration of conformity
Available	Available
Available	Available

Contractual warranty

Warranty period	18 months
-----------------	-----------

Dimensions

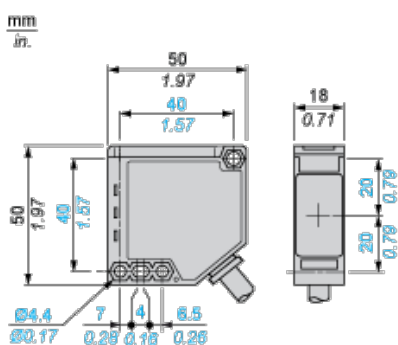

Wiring Schemes

PNP Output

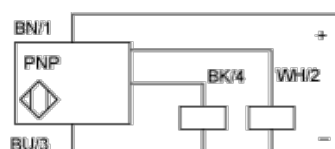

(+) Brown

BN :

(-) Blue

BU :

(OUT/Output)Black

BK :

(Alarm)White

WH :

NPN Output

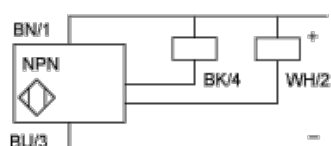

- (+) Brown
- BN :
- (-) Blue
- BU :
- (OUT/Output)Black
- BK :
- (Alarm)White
- WH :

Detection Curves

With Thru-beam Accessory (Thru-beam)

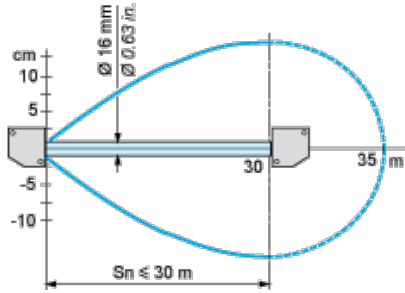

Without Accessory (Diffuse)

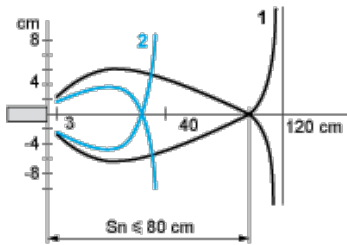

- 1 : White 90%
 - 2 : Grey 18%
- Object 10 x 10 cm

Without Accessory (Diffuse with background suppression)

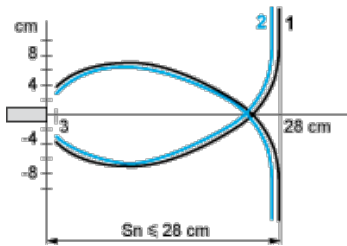

- 1 : White 90%
 - 2 : Grey 18%
- Object 10 x 10 cm

With reflector (Polarised reflex)

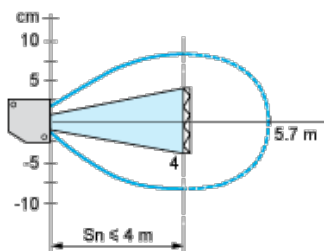

With reflector XUZC50

Variation of Usable Sensing Distance S_u (Without accessory, with adjustable background suppression)

Teach Mode at Minimum

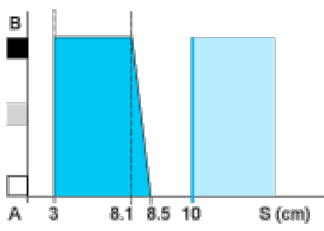

Teach Mode at Maximum

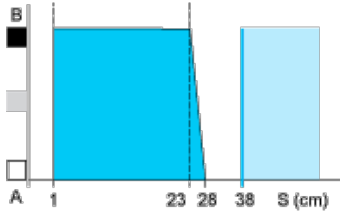

- (1) Black
- (2) Grey
- (3) White
- (4) Sensing range
- (5) Non sensing zone (matt surfaces)

A-B :Object reflection coefficient

- (1) Black 6%
- (2) Grey 18%
- (3) White 90%
- (4) Sensing range
- (5) Non sensing zone (matt surfaces)