

XSPN05122EX

induktivni senzor XSP M18 - D 41 mm - plastičan - Sn
5 mm–7..12 V DC - kabel 2m



Glavno

Range of product	OsiSense XS ATEX D
Series name	Application
Sensor type	Inductive proximity sensor
Device application	ATEX dust
Sensor name	XSP
Sensor design	Cylindrical M18
Size	41 mm
Body type	Fixed
Detector flush mounting acceptance	Flush mountable
Material	Plastic
Enclosure material	Plastic
[Sn] nominal sensing distance	5 mm
Type of output signal	Discrete
Wiring technique	2-wire
Discrete output function	1 NC
Output circuit type	DC
Discrete output type	Namur
Electrical connection	Cable
Cable length	2 m
[Us] rated supply voltage	7...12 V DC
Switching capacity in mA	<= 1 mA
IP degree of protection	IP67 conforming to IEC 60529

Komplementarno

Thread type	M18 x 1
Detection face	Frontal
Front material	PPS
Operating zone	0...4 mm
Cable composition	2 x 0.34 mm ²
Wire insulation material	PvR
Residual current	<= 3 mA open state
Switching frequency	<= 500 Hz
Marking	II1 D-Ex ia IIIC T85°C Da IP66/67
Threaded length	29 mm
Height	18 mm
Length	41 mm

Okolina

standards	EN/IEC 60079-0 EN/IEC 60079-11
directives	94/9/EC - ATEX directive
product certifications	INERIS 04ATEX0016X
ambient air temperature for operation	-20...60 °C
dust zone	Zone 20

Informacije dane u ovoj dokumentaciji sadrže opće opise i/ili tehničke karakteristike o performansama ovdje sadržanih proizvoda. Ova dokumentacija nije namijenjena kao zamjena za niti bi se trebala koristiti za određivanje prikladnosti ili pouzdanosti predmetnih proizvoda za konkretne korisničke primjene. Svaki takav korisnik ili integrator dužan je provesti odgovarajuću i potpunu analizu rizika, procjenu i ispitivanje proizvoda u odnosu na odgovarajuću specifičnu primjenu ili uporabu istog. Niti društvo Schneider Electric Industries SAS niti bilo koje od njegovih povezanih poduzeća ili podružnica neće preuzeti obvezu ili snositi odgovornost za pogrešnu upotrebu ovdje sadržanih informacija.

Offer Sustainability

Not Green Premium product

Not Green Premium product

Will not be Compliant

Will not be Compliant

Contractual warranty

Warranty period

18 months

Dimensions

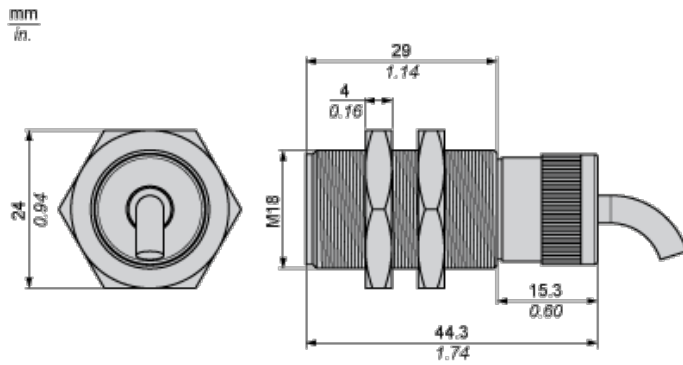

Minimum Mounting Distances

Side by side

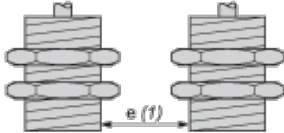

$e (1)$ 10 mm/0.39 in.

≧

Face to face

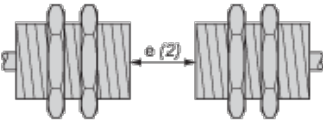

$e (2)$ 60 mm/2.36 in.

≧

Facing a metal object

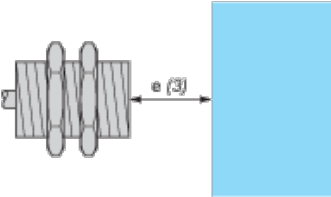

$e (3)$ 15 mm/0.60 in

≧

Mounting

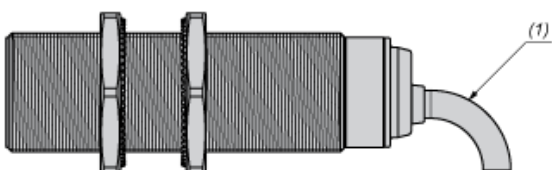

(1) Bending cable: 4 x external cable diameter

Wiring Schemes

2-Wire Non-polarised

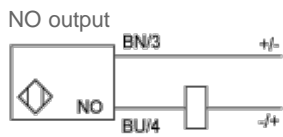

BU : Blue

BN : Brown

Performance Curves

Standard Steel Target : 18x18x1 mm

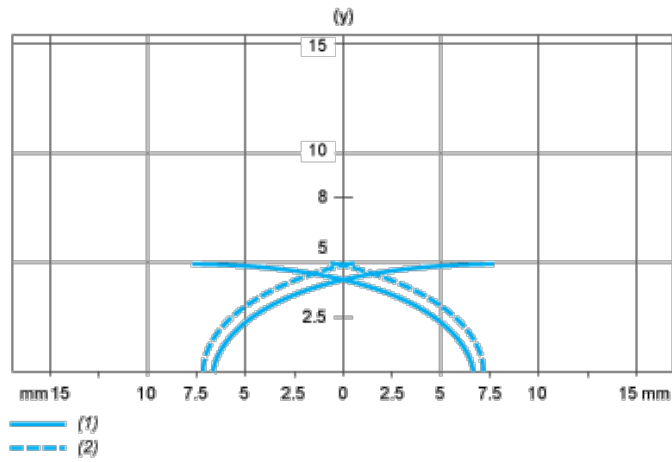

(1) Pick-up points

(2) Drop-out points (object approaching from the side)

(y) Sensing distance in mm