

## XS1N05NA310

induktivni senzor XS1 M5 – D 29 mm – mjed – Sn 1 mm – 5.. 24 V DC – kabel od 2 m



### Glavno

Range of product	OsiSense XS
Series name	General purpose
Sensor type	Inductive proximity sensor
Device application	-
Sensor name	XS1
Sensor design	Cylindrical M5
Size	29 mm
Body type	Fixed
Detector flush mounting acceptance	Flush mountable
Material	Metal
Type of output signal	Discrete
Wiring technique	3-wire
[Sn] nominal sensing distance	1 mm
Discrete output function	1 NO
Output circuit type	DC
Discrete output type	NPN
Electrical connection	Cable
Cable length	2 m
[Us] rated supply voltage	5...24 V DC
Switching capacity in mA	<= 100 mA with overload and short-circuit protection
IP degree of protection	IP67 conforming to IEC 60529

### Komplementarno

Thread type	M5 x 0.5
Detection face	Frontal
Front material	PPS
Enclosure material	Nickel plated brass
Operating zone	0...0.8 mm
Cable composition	3 x 0.11 mm <sup>2</sup>
Wire insulation material	PvR
Status LED	1 LED yellow for output state
Supply voltage limits	5...30 V DC
Switching frequency	<= 5000 Hz
Voltage drop	<= 2 V at closed state
Current consumption	<= 10 mA at no-load
Delay first up	<= 5 ms
Delay response	<= 1 ms
Delay recovery	<= 1 ms
Marking	CE
Threaded length	29 mm
Height	5 mm
Length	28 mm
Product weight	0.03 kg

Informacije dane u ovoj dokumentaciji sadrže opće opise i/ili tehničke karakteristike o performansama ovdje sadržanih proizvoda. Ova dokumentacija nije namijenjena kao zamjena za niti bi se trebala koristiti za određivanje prikladnosti ili pouzdanosti predmetnih proizvoda za konkretne korisničke primjene. Svaki takav korisnik ili integrator dužan je provesti odgovarajuću i potpunu analizu rizika, procjenu i ispitivanje specifičnu primjenu ili uporabu istog. Niti društvo Schneider Electric Industries SAS niti bilo koje od njegovih povezanih poduzeća ili podružnica neće preuzeti obvezu ili snositi odgovornost za pogrešnu upotrebu ovdje sadržanih informacija.

## Okolina

product certifications	CSA UL
ambient air temperature for operation	-25...70 °C
ambient air temperature for storage	-40...85 °C
vibration resistance	25 gn amplitude = +/- 2 mm (f = 10...55 Hz) conforming to IEC 60068-2-6
shock resistance	50 gnfor 11 ms conforming to IEC 60068-2-27

## Offer Sustainability

Green Premium product	Green Premium product
Compliant - since 0935 - Schneider Electric declaration of conformity	Compliant - since 0935 - Schneider Electric declaration of conformity
Reference not containing SVHC above the threshold	Reference not containing SVHC above the threshold
Available	Available
Available	Available

## Contractual warranty

Warranty period	18 months
-----------------	-----------

## Dimensions

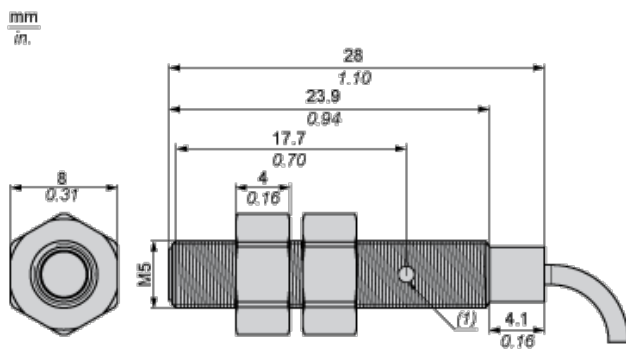

(1) LED

## Minimum Mounting Distances in mm

Side by side

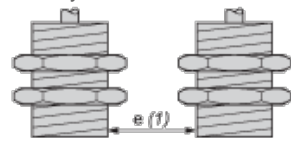

e (1) 2 mm/0.79 in.

≥

Face to face

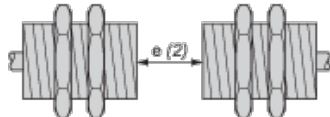

e (2) 12 mm/0.47 in.

≥

Facing a metal object



e (3) 3 mm/0.12 in.

≥

Mounted in a metal support

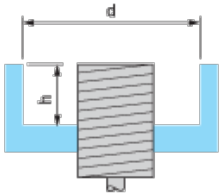

d ≥ 5 mm/0.17 in.

h ≥ 0 mm/0 in.

Tightening torque : 1.6 N.m. (values obtained with washers mounted)

## Mounting

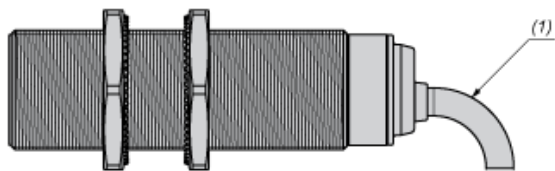

(1) Bending cable: 4 x external cable diameter

## Wiring Schemes

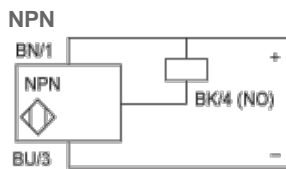

BU : Blue

BN : Brown

BK : Black

## Performance Curves

Standard Steel Target (mm) : 5x5x1

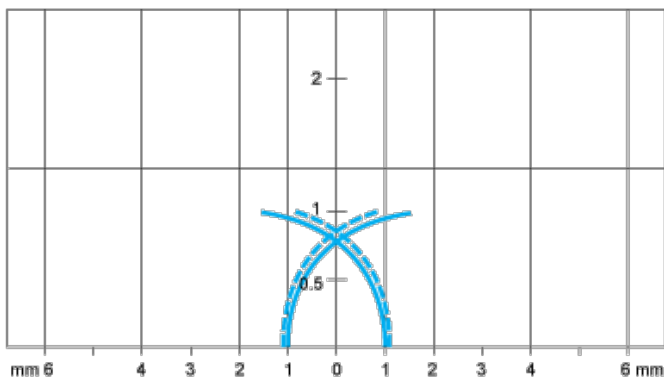

— Pick-up points

- - - Drop-out points (object approaching from the side)

(y) Sensing distance in mm