

XS1M30MB250K

induktivni senzor XS1 M30 – D 72 mm – mjed – Sn
10 mm - 24.. 240 V AC/DC - 1/2"



Glavno

Range of product	OsiSense XS
Series name	General purpose
Sensor type	Inductive proximity sensor
Wiring configuration	2-wire
Output circuit type	AC/DC
Protection type	Short-circuit protection
Device application	2-wire DC short-circuit protection
Sensor name	XS1
Sensor design	Cylindrical M30
Size	72 mm
Body type	Fixed
Detector flush mounting acceptance	Flush mountable
Material	Metal
Type of output signal	Discrete
Wiring technique	2-wire
[Sn] nominal sensing distance	10 mm
Discrete output function	1 NC
Electrical connection	3 pins 1/2"20 UNF male connector
[Us] rated supply voltage	24...240 V AC 50/60 Hz 24...210 V DC
Switching capacity in mA	5...200 mA DC with overload and short-circuit protection 5...300 mA AC with overload and short-circuit protection
IP degree of protection	IP67 conforming to IEC 60529

Komplementarno

Thread type	M30 x 1.5
Detection face	Frontal
Front material	PPS
Enclosure material	Nickel plated brass
Operating zone	0...8 mm
Differential travel	1...15% of Sr
Status LED	1 LED green for supply on 1 LED yellow for output state
Supply voltage limits	20...264 V AC/DC
Residual current	<= 1.5 mA for open state
Switching frequency	<= 2000 Hz DC <= 25 Hz AC
Voltage drop	<= 5.5 V at closed state
Delay first up	<= 70 ms
Delay response	<= 2 ms
Delay recovery	<= 5 ms
Marking	CE
Threaded length	51 mm

Informacije dane u ovoj dokumentaciji sadrže opće opise i/ili tehničke karakteristike o performansama ovdje sadržanih proizvoda. Ova dokumentacija nije namijenjena kao zamjena za niti bi se trebala koristiti za određivanje prikladnosti ili pouzdanosti predmetnih proizvoda za konkretne korisničke primjene. Svaki takav korisnik ili integrator dužan je provesti odgovarajuću i potpunu analizu rizika, procjenu i ispitivanje proizvoda u odnosu na odgovarajuću specifičnu primjenu ili uporabu istog. Niti društvo Schneider Electric Industries SAS niti bilo koje od njegovih povezanih podružnica neće preuzeti obvezu ili snositi odgovornost za pogrešnu upotrebu ovdje sadržanih informacija.

Height	30 mm
Length	72 mm
Product weight	0.145 kg

Okolina

product certifications	CCC CSA UL
ambient air temperature for operation	-25...70 °C
ambient air temperature for storage	-40...85 °C
vibration resistance	25 gn amplitude = +/- 2 mm (f = 10...55 Hz) conforming to IEC 60068-2-6
shock resistance	50 gnfor 11 ms conforming to IEC 60068-2-27

Offer Sustainability

Green Premium product	Green Premium product
Compliant - since 0811 - Schneider Electric declaration of conformity	Compliant - since 0811 - Schneider Electric declaration of conformity
Reference not containing SVHC above the threshold	Reference not containing SVHC above the threshold
Available	Available
Available	Available

Contractual warranty

Warranty period	18 months
-----------------	-----------

Dimensions

mm
in.

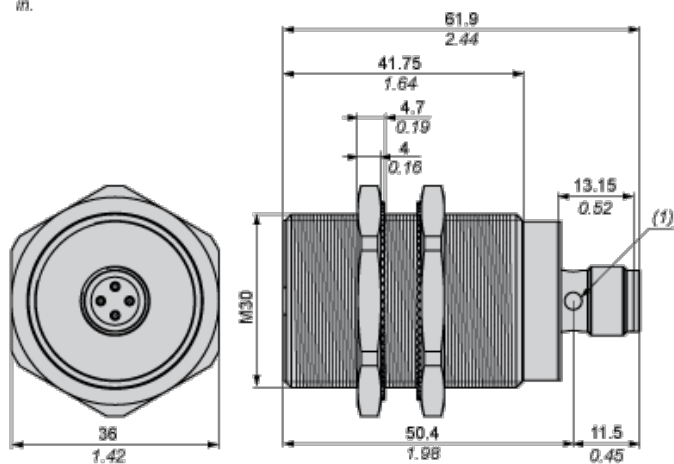

(1) LED

Minimum Mounting Distances

Side by side

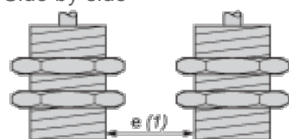

$e (1)$ 20 mm/0.79 in

\geq

Face to face

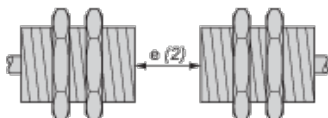

e (2) 120 mm/4.72 in

≧

Facing a metal object

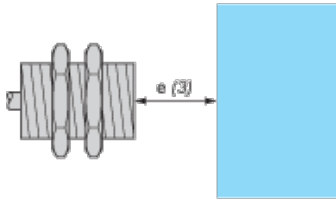

e (3) 30 mm/1.18 in.

≧

Wiring Schemes

1/2"-20UNF
1/2"-20UNF

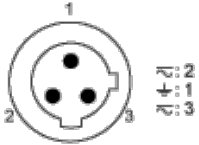

1 : Grounding

2 : AC

3 : AC

NC output

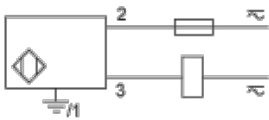

Performance Curves

Standard Steel Target : 30x30x1 mm

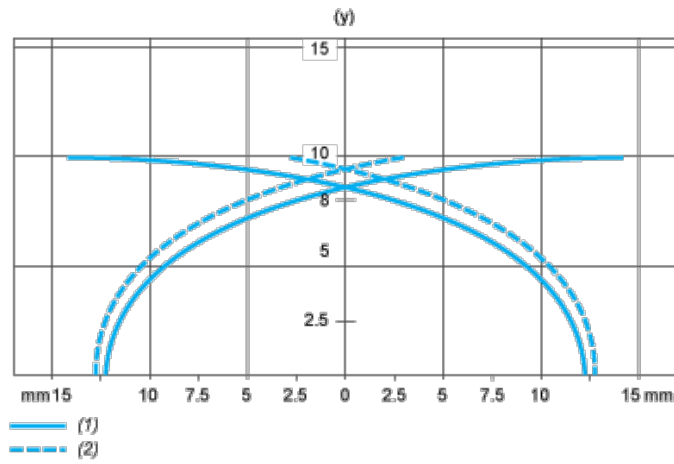

(1) Pick-up points

(2) Drop-out points (object approaching from the side)

(y) Sensing distance in mm