

XS1M18PAS40

induktivni senzor XS1 M18–D 60mm–nehrđajući
čelik–Sn 5 mm–12..24 V DC - kabel 2m



Glavno

Range of product	OsiSense XS
Series name	Application
Sensor type	Inductive proximity sensor
Device application	Selective detection of ferrous materials
Sensor name	XS1
Sensor design	Cylindrical M18
Size	60 mm
Body type	Fixed
Detector flush mounting acceptance	Flush mountable
Material	Stainless steel
Type of output signal	Discrete
Wiring technique	3-wire
[Sn] nominal sensing distance	5 mm
Discrete output function	1 NO
Output circuit type	DC
Discrete output type	PNP
Electrical connection	Cable
Cable length	2 m
[Us] rated supply voltage	12...24 V DC with reverse polarity protection
Switching capacity in mA	<= 200 mA with overload and short-circuit protection
IP degree of protection	IP68 conforming to IEC 60529

Komplementarno

Thread type	M18 x 1
Detection face	Frontal
Front material	PPS
Enclosure material	Stainless steel : 304 CU
Operating zone	0...4 mm
Cable composition	3 x 0.34 mm ²
Wire insulation material	PvR
Status LED	1 LED yellow for output state
Supply voltage limits	10...38 V DC
Switching frequency	<= 1000 Hz
Voltage drop	<= 2.6 V at closed state
Current consumption	0...15 mA at no-load
Delay first up	<= 10 ms
Delay response	<= 0.3 ms
Delay recovery	<= 0.7 ms
Marking	CE
Threaded length	52 mm
Length	60 mm
Product weight	0.12 kg

Informacije dane u ovoj dokumentaciji sadrže opće opise i/ili tehničke karakteristike o performansama ovdje sadržanih proizvoda. Ova dokumentacija nije namijenjena kao zamjena za niti bi se trebala koristiti za određivanje prikladnosti ili pouzdanosti predmetnih proizvoda za konkretne korisničke primjene. Svaki takav korisnik ili integrator dužan je provesti odgovarajuću i poplunu analizu rizika, procjenu i ispitivanje specifičnu primjenu ili uporabu istog. Niti društvo Schneider Electric Industries SAS niti bilo koje od njegovih povezanih poduzeća ili podružnica neće preuzeti obvezu ili snositi odgovornost za pogrešnu upotrebu ovdje sadržanih informacija.

Okolina

product certifications	CSA UL
ambient air temperature for operation	-25...70 °C

Offer Sustainability

Green Premium product	Green Premium product
Compliant - since 1104 - Schneider Electric declaration of conformity	Compliant - since 1104 - Schneider Electric declaration of conformity
Reference not containing SVHC above the threshold	Reference not containing SVHC above the threshold
Available	Available
Available	Available

Contractual warranty

Warranty period	18 months
-----------------	-----------

Dimensions

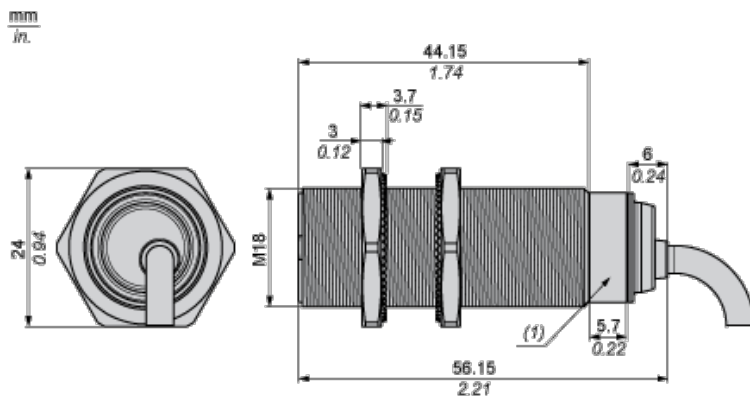

(1) LED

Minimum Mounting Distances

Side by side

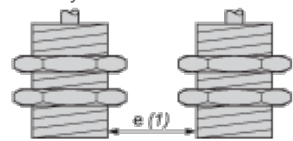

e (1) 10 mm/0.39 in.

≧

Face to face

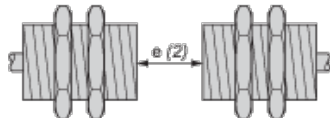

e (2) 60 mm/2.36 in.

≧

Facing a metal object

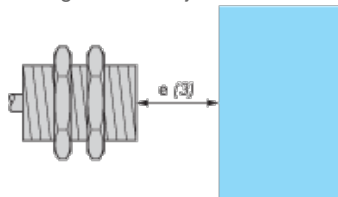

e (3) 15 mm/0.60 in

≧

Mounting

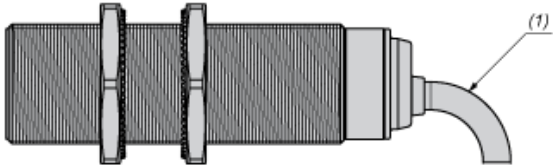

(1) Bending cable: 4 x external cable diameter

Wiring Schemes

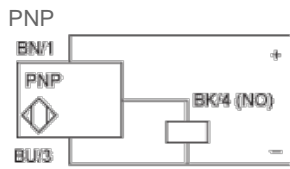

BU : Blue
BN : Brown
BK : Black

Performance Curves

Standard Steel Target : 18x18x1 mm

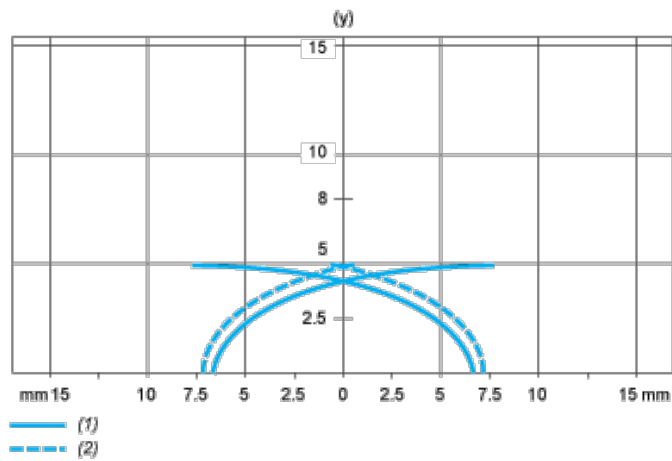

- (1) Pick-up points
- (2) Drop-out points (object approaching from the side)
- (y) Sensing distance in mm