

XCKD3910P16EX

granična sklopka XCK-D – utisni klip – 2 NC + 1 NO
– ATEX



Glavno

Range of product	OsiSense ATEX D
Series name	Standard format
Product or component type	Limit switch
Device short name	XCKD
Sensor design	Compact form B conforming to CENELEC EN 50047
Body type	Fixed
Head type	Plunger head
Material	Metal
Fixing mode	By the body
Movement of operating head	Linear
Type of operator	Metal spring return plunger
Switch actuation	On end
Type of approach	Vertical approach, 1 direction
Electrical connection	Screw-clamp terminals, 1 x 0.34...2 x 0.75 mm ²
Cable entry number	1 tapped entry (M16 x 1.5) for cable gland (included), cable outer diameter: 4...8 mm
Number of poles	3
Contacts type and composition	2 NC + 1 NO
Contacts insulation form	Zb
Contact operation	Snap action
Number of steps	1
Positive opening	With
Minimum force for tripping	15 N
Maximum actuation speed	0.5 m/s
IP degree of protection	IP66 conforming to IEC 60529 IP67 conforming to IEC 60529

Komplementarno

Body material	Zamak
Head material	Zamak
Positive opening minimum force	45 N
Minimum actuation speed	0.01 m/min
Contact code designation	B300, AC-15 (240 V, I _e = 1.5 A) conforming to EN 60947-5-1 B300, AC-15 (240 V, I _e = 1.5 A) conforming to IEC 60947-5-1 appendix A R300, DC-13 (250 V, I _e = 0.1 A) conforming to EN 60947-5-1 R300, DC-13 (250 V, I _e = 0.1 A) conforming to IEC 60947-5-1 appendix A
[I _{th}] conventional enclosed thermal current	6 A AC
[U _i] rated insulation voltage	400 V, pollution degree: 3 conforming to IEC 60947-1 300 V conforming to UL 508 300 V conforming to CSA C22.2 No 14
Resistance across terminals	<= 25 MOhm conforming to IEC 60255-7 category 3
[U _{imp}] rated impulse withstand voltage	4 kV conforming to IEC 60664 4 kV conforming to IEC 60947-1
Short-circuit protection	6 A cartridge fuse, type gG
Electrical durability	5000000 cycles DC-13 120 V 2 W, <= 3600 cyc/mn load factor: 0.5 conforming to IEC 60947-5-1 appendix C inductive DC 5000000 cycles DC-13 24 V 4 W, <= 3600 cyc/mn load factor: 0.5 conforming to IEC

Informacije dane u ovoj dokumentaciji sadrže opće opise i/ili tehničke karakteristike o performansama ovdje sadržanih proizvoda. Ova dokumentacija nije namijenjena kao zamjena za niti bi se trebala koristiti za određivanje prikladnosti ili pouzdanosti predmetnih proizvoda za konkretne korisničke primjene. Svaki takav korisnik ili integrator dužan je provesti odgovarajuću i potpunu analizu rizika, procjenu i ispitivanje proizvoda u odnosu na odgovarajuću specifičnu primjenu ili uporabu istog. Niti društvo Schneider Electric, Industries SAS niti bilo koje od njegovih povezanih poduzeća ili podružnica neće preuzeti obvezu ili snositi odgovornost za pogrešnu upotrebu ovdje sadržanih informacija.

Mechanical durability	15000000 cycles
Marking	II2 D-Ex tb IIIC T85°C Db IP66/67
Width	31 mm
Height	65 mm
Depth	30 mm

Okolina

shock resistance	50 gnfor 11 ms conforming to IEC 60068-2-27
vibration resistance	25 gn 10...500 Hz IEC 60068-2-6
electrical shock protection class	Class I conforming to IEC 61140 Class I conforming to NF C 20-030
ambient air temperature for operation	-20...60 °C
protective treatment	TC
dust zone	Zone 21 - 22
product certifications	INERIS 04ATEX0014X IEC-Ex INE 17.0020X
standards	EN/IEC 60079-0 EN/IEC 60079-31
directives	2014/34/EU - ATEX directive

Offer Sustainability

Green Premium product	Green Premium product
Compliant - since 1002 - Schneider Electric declaration of conformity	Compliant - since 1002 - Schneider Electric declaration of conformity
Reference not containing SVHC above the threshold	Reference not containing SVHC above the threshold
Need no specific recycling operations	Need no specific recycling operations

Contractual warranty

Warranty period	18 months
-----------------	-----------

Dimensions

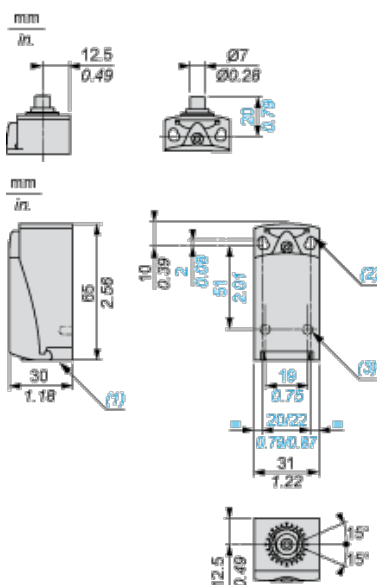

- (1) Tapped entry for M16 x 1.5
- (2) 2 elongated holes \varnothing 4.3 x 6.3 mm on 22 mm centres, 2 holes \varnothing 4.3 on 20 mm centres.
- (3) 2 x \varnothing 3 holes for support studs, depth 4 mm.

Mounting with Cable Entry

Position of Cable Gland

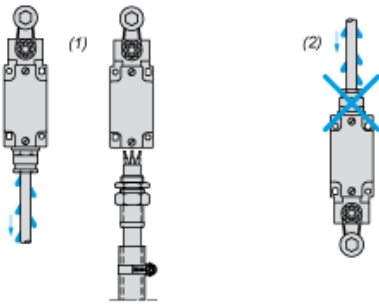

- (1) Recommended
- (2) To be avoided

Setting-up

Plunger or Multi-directional Heads

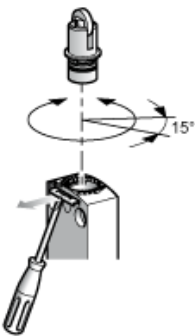

Wiring Diagram

3-pole NC + NC + NO Snap Action

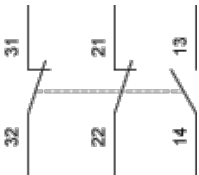

Characteristics of Actuation

Switch Actuation on End

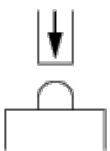

Functionnal Diagram

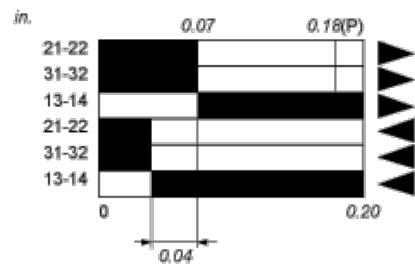
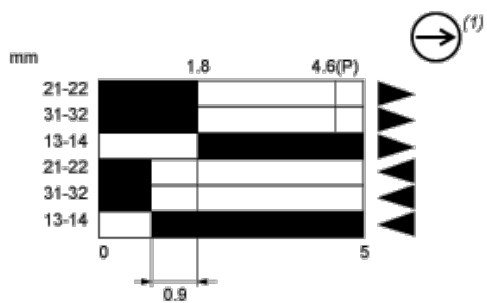

- (2)
- (3)
- ▶ (4)
- ◀ (5)

- (P) Positive opening point
- (1) NC contact with positive opening operation
- (2) Closed
- (3) Open
- (4) Tripping
- (5) Resetting