

## XCKD2102M12

granična sklopka XCKD–utisni klip s čeličnim kotačićem–1 NC + 1 NO–brzi–M12



### Glavno

Range of product	OsiSense XC
Series name	Standard format
Product or component type	Limit switch
Device short name	XCKD
Sensor design	Compact form C conforming to CENELEC EN 50047
Body type	Fixed
Head type	Plunger head
Material	Metal
Body material	Zamak
Head material	Zamak
Fixing mode	By the body
Movement of operating head	Linear
Type of operator	Spring return roller plunger metal
Type of approach	Lateral approach 2 directions
Number of poles	2
Contacts type and composition	1 NC + 1 NO
Contact operation	Snap action

### Komplementarno

Switch actuation	By 30° cam
Electrical connection	Male connector M12, 5 pins
Contacts insulation form	Zb
Positive opening	With
Positive opening minimum force	36 N
Minimum force for tripping	12 N
Maximum actuation speed	0.5 m/s
Repeat accuracy	0.1 mm on the tripping points with 1 million operating cycles
[Ie] rated operational current	3 A at 50 V, AC-15 conforming to EN/IEC 60947-5-1 appendix A 0.27 A at 50 V, DC-13 conforming to EN/IEC 60947-5-1 appendix A
[Ithe] conventional enclosed thermal current	4 A
[Ui] rated insulation voltage	60 V degree of pollution 3 conforming to IEC 60947-1
Resistance across terminals	<= 25 MOhm conforming to IEC 60255-7 category 3
[Uimp] rated impulse withstand voltage	0.8 kV conforming to IEC 60664 0.8 kV conforming to IEC 60947-1
Short-circuit protection	4 A by gG cartridge fuse
Electrical durability	5000000 cycles, DC-13, 24 V, 10 W, operating rate: <= 60 cyc/mn, load factor: 0.5 conforming to IEC 60947-5-1 appendix C 5000000 cycles, DC-13, 48 V, 7 W, operating rate: <= 60 cyc/mn, load factor: 0.5 conforming to IEC 60947-5-1 appendix C
Mechanical durability	10000000 cycles
Width	31 mm
Height	65 mm
Depth	30 mm
Product weight	0.195 kg
Terminals description ISO n°1	(13-14)NO

Informacije dane u ovoj dokumentaciji sadrže opće opise i/ili tehničke karakteristike o performansama ovdje sadržanih proizvoda. Ova dokumentacija nije namijenjena kao zamjena za niti bi se trebala koristiti za određivanje prikladnosti ili pouzdanosti predmetnih proizvoda za konkretne korisničke primjene. Svaki takav korisnik ili integrator dužan je provesti odgovarajuću i potpunu analizu rizika, procjenu i ispitivanje proizvoda u odnosu na odgovarajuću specifičnu primjenu ili uporabu istog. Niti društvo Schneider Electric, Industries SAS niti bilo koje od njegovih povezanih poduzeća ili podružnica neće preuzeti obvezu ili snositi odgovornost za pogrešnu upotrebu ovdje sadržanih informacija.

## Okolina

shock resistance	50 gn (duration = 11 ms) conforming to IEC 60068-2-27
vibration resistance	25 gn (f = 10...500 Hz) conforming to IEC 60068-2-6
IK degree of protection	IK06 conforming to EN 50102
electrical shock protection class	Class I conforming to IEC 61140 Class I conforming to NF C 20-030
ambient air temperature for operation	-25...70 °C
ambient air temperature for storage	-40...70 °C
protective treatment	TC
product certifications	CCC CSA UL
standards	EN 60204-1 EN 60947-5-1 IEC 60204-1 IEC 60947-5-1 UL 508 CSA C22.2 No 14

## Offer Sustainability

Green Premium product	Green Premium product
Compliant - since 1002 - Schneider Electric declaration of conformity	Compliant - since 1002 - Schneider Electric declaration of conformity
Reference not containing SVHC above the threshold	Reference not containing SVHC above the threshold
Need no specific recycling operations	Need no specific recycling operations

## Contractual warranty

Warranty period	18 months
-----------------	-----------

## Dimensions

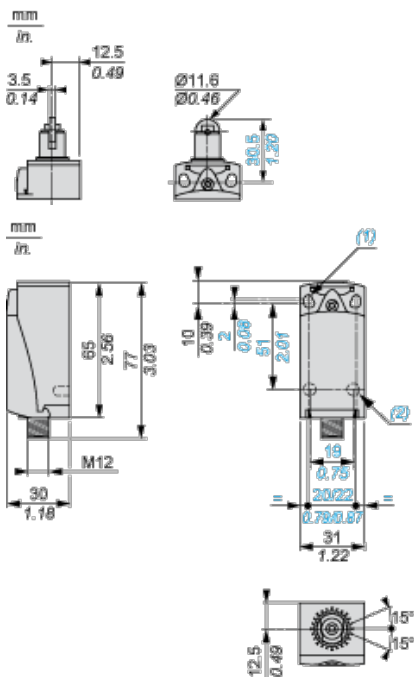

- (1) 2 elongated holes  $\varnothing$  4.3 x 6.3 mm on 22 mm centres, 2 holes  $\varnothing$  4.3 on 20 mm centres.  
 (2) 2 x  $\varnothing$  3 holes for support studs, depth 4 mm.

## Mounting with Cable Entry

## Position of Cable Gland

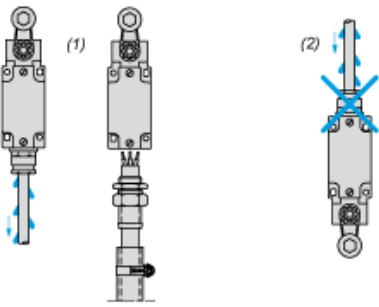

- (1) Recommended
- (2) To be avoided

## Setting-up

### Plunger or Multi-directional Heads

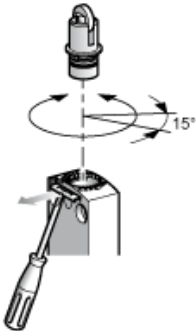

## Wiring Diagram

### 2-pole NC + NO Snap Action

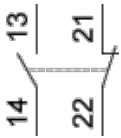

## Connections

### M12 Connector

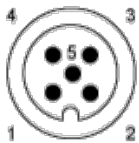

- 1-2 : NC
- 3-4 : NO
- 5 : Grounding

## Characteristics of Actuation

### Switch Actuation by 30° Cam

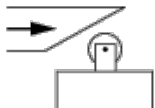

## Functionnal Diagram

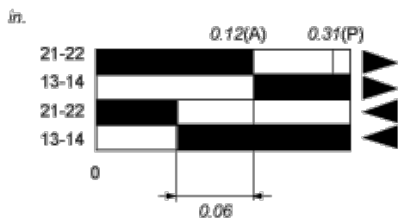
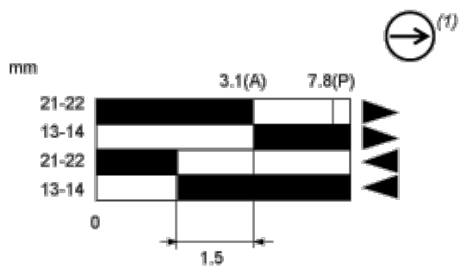

- (2)
- (3)
- ▶ (4)
- ◀ (5)

- (P) Positive opening point
- (A) Cam displacement
- (1) NC contact with positive opening operation
- (2) Closed
- (3) Open
- (4) Tripping
- (5) Resetting