

XCC3912PS84SGN

apsolutni enkoder Ø 90 višekretajni – čvrsta osovina
12 mm – SSI 25-bitni sivi

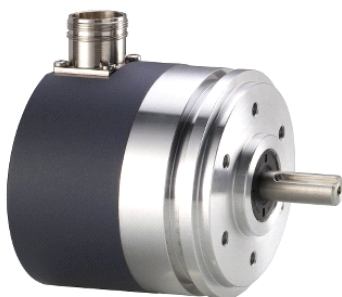

Glavno

Range of product	OsiSense XCC
Encoder type	Multiturn absolute encoder
Device short name	XCC
Product specific application	-
Diameter	90 mm
Shaft diameter	12 mm
Shaft type	Solid shaft
Resolution	4096 turns/8192 points
Electrical connection	1 male connector M23 radial 12 pins
Output stage	Type SG
Type of output stage	SSI 25-bit gray
[Us] rated supply voltage	11...30 V DC
Enclosure material	Zamak

Komplementarno

Shaft tolerance	G6
Residual ripple	500 mV
Maximum revolution speed	6000 rpm
Shaft moment of inertia	150 g.cm ²
Torque value	0.01 N.m
Maximum load	10 daN axial 20 daN radial
Output frequency	100...500 kHz
Current consumption	0...100 mA no-load
Protection type	Reverse polarity protection Short-circuit protection
Physical interface	RS422
Output level	High level: 2 V minimum 20 mA
Surge withstand	1 kV level 2 IEC 61000-4-5
Base material	Aluminium
Shaft material	Stainless steel
Type of ball bearings	6000ZZ
Product weight	1.84 kg

Okolina

marking	CE
ambient air temperature for operation	-20...85 °C
ambient air temperature for storage	-30...85 °C
IP degree of protection	IP66 IEC 60529
vibration resistance	10 gn (10...2000 Hz) IEC 60068-2-6
shock resistance	30 gn (11 ms) IEC 60068-2-27
resistance to electrostatic discharge	4 kV contact discharge level 3 IEC 61000-4-2 8 kV air discharge level 3 IEC 61000-4-2
resistance to electromagnetic fields	10 V/m level 3 IEC 61000-4-3
resistance to fast transients	1 kV signal ports level 3 IEC 61000-4-4 2 kV power ports level 3 IEC 61000-4-4

Informacije dane u ovoj dokumentaciji sadrže opće opise i/ili tehničke karakteristike o performansama ovdje sadržanih proizvoda.
 Ova dokumentacija nije namijenjena kao zamjena za niti bi se trebala koristiti za određivanje prikladnosti ili pouzdanosti predmetnih proizvoda za konkretne korisničke primjene.
 Svaki takav korisnik ili integrator dužan je provesti odgovarajuću i potpunu analizu rizika, procjenu i ispitivanje proizvoda u odnosu na odgovarajuću specifičnu primjenu ili uporabu istog.
 Niti društvo Schneider Electric Industries SAS niti bilo koje od njegovih povezanih poduzeća ili podružnica neće preuzeti obvezu ili snositi odgovornost za pogrešnu upotrebu ovdje sadržanih informacija.

Offer Sustainability

Not Green Premium product	Not Green Premium product
Compliant - since 0701 - Schneider Electric declaration of conformity	Compliant - since 0701 - Schneider Electric declaration of conformity
Reference not containing SVHC above the threshold	Reference not containing SVHC above the threshold

Contractual warranty

Warranty period	18 months
-----------------	-----------

Dimensions

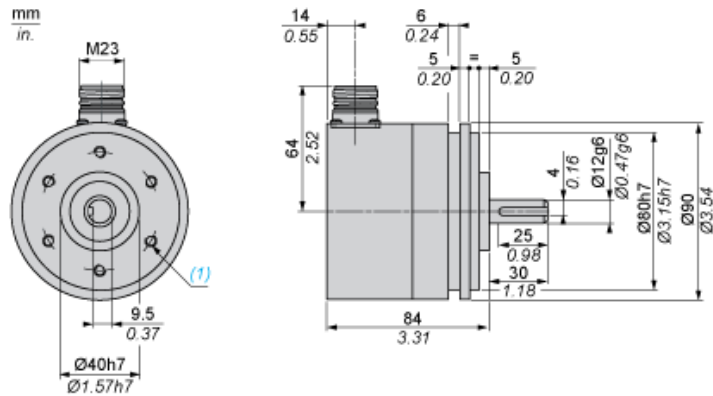

(1) 6 holes M6 x 1 at 120° on 60 PCD, depth: 12 mm maximum

Wiring Diagram

M23, 12-pin Connector, Anticlockwise Connections

Male Connector on Encoder

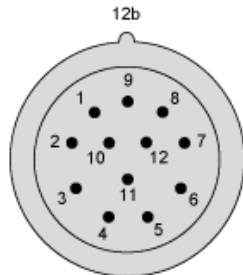

Pin number	1	2	3	4	5	6	7	8	9	10	11	12
Signal Supply	0 V	Data +	Clk +	R	Direction (1)	Reset to zero	R	+ V	R	Data -	Clk -	R

(1) ↻ : Clockwise direction

↻ : Anticlockwise direction

R = Reserved (do not connect)

Technical Description

RS 422 Data Output

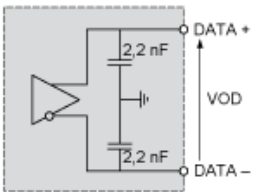

(1)

(1) $I_{data} = 20 \text{ mA}$ $|VOD| > 2 \text{ V}$

Isolated Clock Input

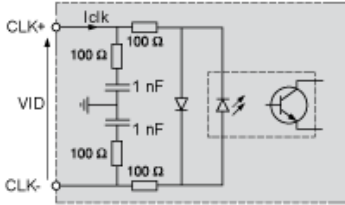

VID maximum: 5 V

Iclk maximum: 15 mA

DIRECTION Input

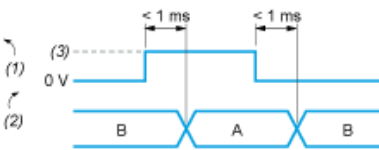

A : Anticlockwise

B : Clockwise

(1) DIRECTION input

(2) DIRECTION of counting

(3) V supply

Input Stage - Reset to Zero

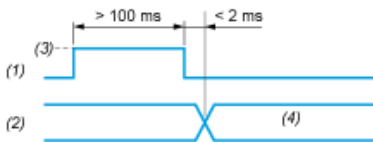

(1) Reset input

(2) Position

(3) V supply

(4) Position=0 (Reset to zero)