

Glavno

Range of product	Modicon M258
Product or component type	Logic controller
Product specific application	-
Discrete I/O number	42
Discrete output number	12for output 4for fast output

Komplementarno

Discrete input number	10for fast input 12for input 4for regular input
Discrete input logic	Sinkfor fast input Sinkfor regular input Sourcefor input
Discrete input voltage	24 V
Discrete input voltage type	DC
Voltage state 1 guaranteed	>= 15 Vfor fast input >= 15 Vfor fast output >= 15 Vfor regular input
Voltage state 0 guaranteed	<= 5 Vfor fast input <= 5 Vfor fast output <= 5 Vfor regular input
Discrete input current	4 mAfor fast input 4 mAfor regular input
Input impedance	6 kOhmfor fast input 6 kOhmfor regular input
Configurable filtering time	0 msfor fast input/regular input and fast output 1.5 msfor fast input/regular input and fast output 12 msfor fast input/regular input and fast output 4 msfor fast input/regular input and fast output
Anti bounce filtering	2 μs...4 ms (configurable) fast input/regular input and fast output
Cable distance between devices	30 m for fast input 30 m for fast output 30 m for regular input
Isolation between channels and internal logic	500 Vrms AC
Isolation between channels	None
Discrete output logic	Source
Discrete output voltage	24 V DC
Output voltage limits	19.2...28.8 V
Discrete output current	4 mAfor fast output
[Us] rated supply voltage	24 V DCfor embedded expert modules power 24 V DCfor I/O power segment 24 V DCfor main supply
Supply voltage limits	20.4...28.8 V
[In] rated current	0.04 Afor embedded expert modules power 0.26 Afor main supply 10 Afor I/O power segment
Peak current	<= 100 kA during <= 70 s main supply

Informacije dane u ovoj dokumentaciji sadrže opće opisne i/ili tehničke karakteristike o performansama ovdje sadržanih proizvoda. Ova dokumentacija nije namijenjena kao zamjena za niti bi se trebala koristiti za određivanje prikladnosti ili pouzdanosti predmetnih proizvoda za konkretne korisničke primjene. Svaki takav korisnik ili integrator dužan je provesti odgovarajuću i potpunu analizu rizika, procjenu i ispitivanje proizvoda u odnosu na odgovarajuću specifičnu primjenu ili uporabu istog. Niti društvo Schneider Electric Industries SAS niti bilo koje od njegovih povezanih poduzeća ili podružnica neće preuzeti obvezu ili snositi odgovornost za pogrešnu upotrebu ovdje sadržanih informacija.

	<= 25 kA during <= 500 s I/O power segment <= 50 kA during <= 150 s embedded expert modules power 1.2 A during > 70 s main supply
Power consumption in W	<= 13.03 W
Execution time per instruction	22 ns: Boolean
Memory description	Flash 128 MB Internal RAM 64 MB
Realtime clock	With user calibration realtime clock, drift: <= 6 s/month Without any user calibration realtime clock, drift: < 30 s/month at 25 °C
Data backed up	Variables of type retain and retain persistent CR2477M Renata, 1.5 years autonomy
Integrated connection type	1 CANopen male SUB-D 9, CANopen master 1 isolated serial link female RJ45, Ethernet Modbus TCP/IP slave (10BASE-T/100BASE-TX) 1 isolated serial link female RJ45, Modbus master/slave RTU/ASCII or character mode ASCII (RS232/RS485), 300...115200 bps 1 isolated serial link mini B USB, 480 Mbit/s 1 isolated serial link USB type A, 480 Mbit/s
Transmission rate	125 kbit/s for bus length of 500 m, CANopen 250 kbit/s for bus length of 250 m, CANopen 50 kbit/s for bus length of 1000 m, CANopen 500 kbit/s for bus length of 100 m, CANopen 10 kbit/s for bus length of 5000 m, CANopen 1000 kbit/s for bus length of 4 m, CANopen 20 kbit/s for bus length of 2500 m, CANopen 800 kbit/s for bus length of 25 m, CANopen
Counting input number	8 counting input(s) 200 kHz
Local signalling	1 LED per channel for I/O state 1 LED for CAN0 STS 1 LED for MBS COM 1 LED green/red for APP0 1 LED green/red for APP1 1 LED green/red for Eth NS (Ethernet network status) 1 LED green/red for Eth ST (Ethernet status) 1 LED green/red for RUN/MS (module status) 1 LED green/red for USB host 1 LED green/yellow for Eth LA (Ethernet activity) 1 LED red for BATT (battery status)
Marking	CE
Mounting support	Symmetrical DIN rail
Width	175 mm
Height	99 mm
Depth	85 mm
Product weight	0.55 kg

Okolina

standards	CSA C22.2 No 142 IEC 61131-2 UL 508 CSA C22.2 No 213
product certifications	CSA C-Tick CULus GOST-R
ambient air temperature for operation	0...50 °C vertical installation 0...55 °C without derating factor horizontal installation 0...60 °C with derating factor horizontal installation
ambient air temperature for storage	-25...70 °C
relative humidity	5...95 % without condensation
IP degree of protection	IP20 conforming to IEC 61131-2
pollution degree	2 conforming to IEC 60664
operating altitude	0...2000 m
storage altitude	0...3000 m
vibration resistance	1 gn 8.4...150 Hz DIN rail 3.5 mm 5...8.4 Hz DIN rail
shock resistance	15 gn for 11 ms
resistance to electrostatic discharge	4 kV on contact conforming to EN/IEC 61000-4-2

	8 kV in air conforming to EN/IEC 61000-4-2
resistance to electromagnetic fields	1 V/m 2...2.7 GHz conforming to EN/IEC 61000-4-3 10 V/m 80...2000 MHz conforming to EN/IEC 61000-4-3
resistance to fast transients	1 kV I/O conforming to EN/IEC 61000-4-4 1 kV shielded cable conforming to EN/IEC 61000-4-4 2 kV power lines conforming to EN/IEC 61000-4-4
surge withstand	0.5 kV differential mode conforming to EN/IEC 61000-4-5 1 kV common mode conforming to EN/IEC 61000-4-5
disturbance radiated/conducted	CISPR 11

Offer Sustainability

Green Premium product	Green Premium product
Compliant - since 1039 - Schneider Electric declaration of conformity	Compliant - since 1039 - Schneider Electric declaration of conformity
Reference not containing SVHC above the threshold	Reference not containing SVHC above the threshold
Available	Available
Available	Available

Contractual warranty

Warranty period	18 months
-----------------	-----------



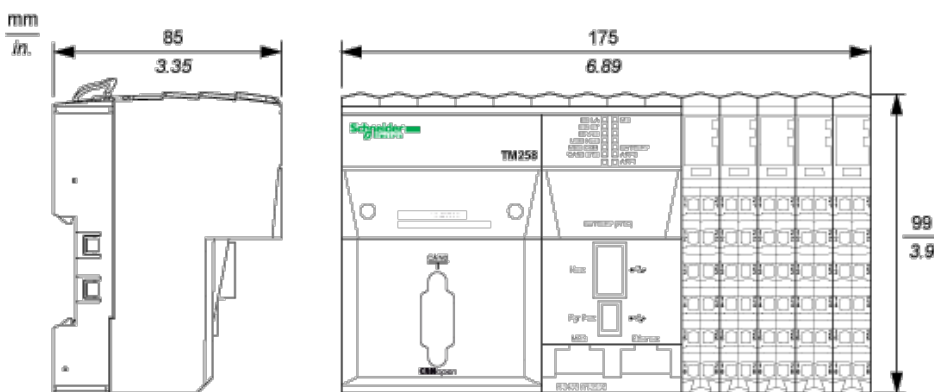

Controller

Dimensions



TM5 System Wiring Recommendations

Wire Sizes to Use with Removable Spring Terminal Blocks

mm in.				
mm ²	0,08...2,5	0,25...2,5	0,25...1,5	2 x 0,25...2 x 0,75
AWG	28...14	24...14	24...16	2 x 24...2 x 18

External Power Supplies

Wiring Diagram of the Controller Power Distribution Module

TM258LD42DT
TM258LF42DT●●

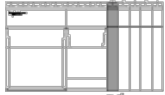

TM258LD42DT4L
TM258LF42DT4L●●



TM258LF66DT4L●●
TM258LF42DR●●

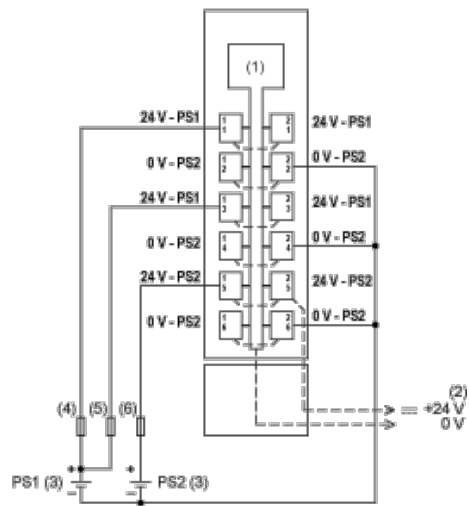
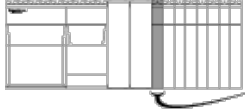

- (1) Internal electronics
- (2) 24 Vdc I/O power segment integrated into the bus bases
- (3) PS1/PS2: External isolated SELV power supply 24 Vdc
- (4) External fuse, Type T slow-blow, 3 A 250 V
- (5) External fuse, Type T slow-blow, 2 A 250 V
- (6) External fuse, Type T slow-blow, 10 A max., 250 V