



### Glavno

Range of product	Modicon M221
Product or component type	Logic controller
[Us] rated supply voltage	100...240 V AC
Discrete input number	24 discrete input conforming to IEC 61131-2 Type 1
Analogue input number	2 at input range: 0...10 V
Discrete output type	Relay normally open
Discrete output number	16 relay
Discrete output voltage	5...125 V DC 5...250 V AC
Discrete output current	2 A

### Komplementarno

Discrete I/O number	40
Number of I/O expansion module	<= 7for relay output
Supply voltage limits	85...264 V
Network frequency	50/60 Hz
Inrush current	<= 40 A
Power consumption in VA	<= 70 VA at 100...240 V with max number of I/O expansion module <= 41 VA at 100...240 V without I/O expansion module
Power supply output current	0.52 A at 5 Vfor expansion bus 0.24 A at 24 Vfor expansion bus
Discrete input logic	Sink or source (positive/negative)
Discrete input voltage	24 V
Discrete input voltage type	DC
Analogue input resolution	10 bits
LSB value	10 mV
Conversion time	1 ms per channel + 1 controller cycle timefor analog input
Permitted overload on inputs	+/- 30 V DCfor analog input with 5 min maximum +/- 13 V DCfor analog input permanent
Voltage state 1 guaranteed	>= 15 Vfor input
Voltage state 0 guaranteed	<= 5 Vfor input
Discrete input current	7 mAfor discrete input 5 mAfor fast input
Input impedance	4.9 kOhmfor fast input 3.4 kOhmfor discrete input 100 kOhmfor analog input
Response time	10 ms turn-on operationfor output 35 µs turn-off operationfor input; I2...I5 terminal 10 ms turn-off operationfor output 5 µs turn-on operationfor fast input; I0, I1, I6, I7 terminal 35 µs turn-on operationfor input; other terminals terminal 5 µs turn-off operationfor fast input; I0, I1, I6, I7 terminal 100 µs turn-off operationfor input; other terminals terminal
Configurable filtering time	0 msfor input 12 msfor input 3 msfor input
Output voltage limits	125 V DC 277 V AC
Current per output common	7 A
Absolute accuracy error	+/- 1 % of full scalefor analog input

Informacije dane u ovoj dokumentaciji sadrže opće opise i/ili tehničke karakteristike o performansama ovdje sadržanih proizvoda. Ova dokumentacija nije namijenjena kao zamjena za niti bi se trebala koristiti za određivanje prikladnosti ili pouzdanosti predmetnih proizvoda za konkretne korisničke primjene. Svaki takav korisnik ili integrator dužan je provesti odgovarajuću i poplunu analizu rizika, procjenu i ispitivanje proizvoda u odnosu na odgovarajuću specifičnu primjenu ili uporabu istog. Niti društvo Schneider Electric Industries SAS niti bilo koje od njegovih povezanih poduzeća ili podružnica neće preuzeti obvezu ili snositi odgovornost za pogrešnu upotrebu ovdje sadržanih informacija.

Electrical durability	Inductive AC-15, (cos phi = 0.35) 240 V/ 120 VA: 100000 cycles Resistive DC-12, 24 V/ 48 W: 100000 cycles Resistive AC-12, 120 V/ 240 VA: 100000 cycles Inductive AC-15, (cos phi = 0.35) 240 V/ 36 VA: 300000 cycles Resistive AC-12, 120 V/ 80 VA: 300000 cycles Inductive (L/R = 7 ms) DC-13, 24 V/ 24 W: 100000 cycles Resistive DC-12, 24 V/ 16 W: 300000 cycles Inductive (L/R = 7 ms) DC-13, 24 V/ 7.2 W: 300000 cycles Inductive AC-14, (cos phi = 0.7) 240 V/ 240 VA: 100000 cycles Inductive AC-15, (cos phi = 0.35) 120 V/ 60 VA: 100000 cycles Inductive AC-14, (cos phi = 0.7) 240 V/ 72 VA: 300000 cycles Inductive AC-15, (cos phi = 0.35) 120 V/ 18 VA: 300000 cycles Resistive AC-12, 240 V/ 480 VA: 100000 cycles Inductive AC-14, (cos phi = 0.7) 120 V/ 120 VA: 100000 cycles Resistive AC-12, 240 V/ 160 VA: 300000 cycles Inductive AC-14, (cos phi = 0.7) 120 V/ 36 VA: 300000 cycles
Switching frequency	20 switching operations/minute with maximum load
Mechanical durability	>= 20000000 cycles for relay output
Minimum load	1 mA at 5 V DC for relay output
Protection type	Without protection at 5 A
Reset time	1 s
Memory capacity	256 kB for user application and data RAM with 10000 instructions 256 kB for internal variables RAM
Data backed up	256 kB built-in flash memory for backup of application and data
Data storage equipment	2 GB SD card optional
Battery type	BR2032 lithium non-rechargeable, battery life: 4 yr
Backup time	1 year at 25 °C by interruption of power supply
Execution time for 1 K instruction	0.3 ms for event and periodic task
Execution time per instruction	0.2 µs Boolean
Exct time for event task	60 µs response time
Maximum size of object areas	512 %M memory bits 8000 %MW memory words 512 %KW constant words 255 %TM timers 255 %C counters
Realtime clock	With
Clock drift	<= 30 s/month at 25 °C
Regulation loop	Adjustable PID regulator up to 14 simultaneous loops
Counting input number	4 fast input (HSC mode) (counting frequency: 100 kHz), counting capacity: 32 bits
Control signal type	A/B Pulse/direction Single phase
Integrated connection type	USB port with connector mini B USB 2.0 Ethernet with connector RJ45 Non isolated serial link "serial 1" with connector RJ45 and interface RS232/RS485
Supply	Serial serial link supply at 5 V 200 mA
Transmission rate	1.2...115.2 kbit/s (115.2 kbit/s by default) for bus length of 15 m - communication protocol: RS485 1.2...115.2 kbit/s (115.2 kbit/s by default) for bus length of 3 m - communication protocol: RS232 480 Mbit/s - communication protocol: USB
Communication port protocol	USB port: USB protocol - SoMachine-Network Non isolated serial link: Modbus protocol master/slave - RTU/ASCII or SoMachine-Network : Ethernet protocol
Port Ethernet	10BASE-T/100BASE-TX 1 port with 100 m copper cable
Communication service	DHCP client Ethernet/IP adapter Modbus TCP server Modbus TCP client Modbus TCP slave device
Local signalling	1 LED red for module error (ERR) 1 LED green for PWR 1 LED green for RUN 1 LED green for SD card access (SD) 1 LED red for BAT 1 LED per channel green for I/O state

	1 LED greenfor SL Ethernet network activity greenfor ACT Ethernet network link yellowfor Link (Link Status)
Electrical connection	Mini B USB 2.0 connector for a programming terminal Terminal block, 3 terminal(s) for connecting the 24 V DC power supply Connector, 4 terminal(s) for analogue inputs Removable screw terminal block for inputs Removable screw terminal block for outputs
Cable distance between devices	Shielded cable: 10 mfor fast input Unshielded cable: 30 mfor output Unshielded cable: 30 mfor digital input Unshielded cable: 1 mfor analog input
Insulation	2300 V AC between output and internal logic Non-insulated between analogue inputs 500 V AC between input and internal logic Non-insulated between analogue input and internal logic 1500 V AC between supply and ground 500 V AC between sensor power supply and ground 500 V AC between input and ground 1500 V AC between output and ground 2300 V AC between supply and internal logic 500 V AC between sensor power supply and internal logic 500 V AC between Ethernet terminal and internal logic 2300 V AC between supply and sensor power supply
Marking	CE
Sensor power supply	24 V DC at 250 mA supplied by the controller
Mounting support	Top hat type TH35-15 rail conforming to IEC 60715 Top hat type TH35-7.5 rail conforming to IEC 60715 Plate or panel with fixing kit
Height	90 mm
Depth	70 mm
Width	160 mm
Product weight	0.456 kg

## Okolina

standards	EN/IEC 60664-1 EN/IEC 61131-2 EN/IEC 61010-2-201
product certifications	ABS CSA CULus LR IACS E10 RCM EAC DNV-GL
environmental characteristic	Ordinary and hazardous location
resistance to electrostatic discharge	4 kV on contact conforming to EN/IEC 61000-4-2 8 kV in air conforming to EN/IEC 61000-4-2
resistance to electromagnetic fields	10 V/m ( 80 MHz...1 GHz) conforming to EN/IEC 61000-4-3 3 V/m ( 1.4 GHz...2 GHz) conforming to EN/IEC 61000-4-3 1 V/m ( 2...2.7 GHz) conforming to EN/IEC 61000-4-3
resistance to magnetic fields	30 A/m 50/60 Hz conforming to EN/IEC 61000-4-8
resistance to fast transients	2 kVfor power lines conforming to EN/IEC 61000-4-4 2 kVfor relay output conforming to EN/IEC 61000-4-4 1 kVfor Ethernet line conforming to EN/IEC 61000-4-4 1 kVfor serial link conforming to EN/IEC 61000-4-4 1 kVfor I/O conforming to EN/IEC 61000-4-4
surge withstand	2 kVfor power lines (AC) in common mode conforming to EN/IEC 61000-4-5 2 kVfor relay output in common mode conforming to EN/IEC 61000-4-5 1 kVfor I/O in common mode conforming to EN/IEC 61000-4-5 1 kVfor shielded cable in common mode conforming to EN/IEC 61000-4-5 0.5 kVfor power lines (DC) in differential mode conforming to EN/IEC 61000-4-5 1 kVfor power lines (AC) in differential mode conforming to EN/IEC 61000-4-5 1 kVfor relay output in differential mode conforming to EN/IEC 61000-4-5 0.5 kVfor power lines (DC) in common mode conforming to EN/IEC 61000-4-5
resistance to conducted disturbances	10 Vrms (0.15...80 MHz) conforming to EN/IEC 61000-4-6 3 Vrms (0.1...80 MHz) conforming to Marine specification (LR, ABS, DNV, GL) 10 Vrms (spot frequency (2, 3, 4, 6.2, 8.2, 12.6, 16.5, 18.8, 22, 25 MHz)) conforming to Marine specification (LR, ABS, DNV, GL)

electromagnetic emission	<p>Conducted emissions conforming to EN/IEC 55011 power lines (AC), 0.15...0.5 MHz : 79 dB<math>\mu</math>V/m QP/66 dB<math>\mu</math>V/m AV</p> <p>Conducted emissions conforming to EN/IEC 55011 power lines (AC), 0.5...300 MHz : 73 dB<math>\mu</math>V/m QP/60 dB<math>\mu</math>V/m AV</p> <p>Conducted emissions conforming to EN/IEC 55011 power lines, 10...150 kHz : 120...69 dB<math>\mu</math>V/m QP</p> <p>Conducted emissions conforming to EN/IEC 55011 power lines, 1.5...30 MHz : 63 dB<math>\mu</math>V/m QP</p> <p>Radiated emissions conforming to EN/IEC 55011 class A 10 m, 30...230 MHz : 40 dB<math>\mu</math>V/m QP</p> <p>Conducted emissions conforming to EN/IEC 55011 power lines, 150...1500 kHz: 79...63 dB<math>\mu</math>V/m QP</p> <p>Radiated emissions conforming to EN/IEC 55011 class A 10 m, 200...1000 MHz: 47 dB<math>\mu</math>V/m QP</p>
immunity to microbreaks	10 ms
ambient air temperature for operation	-10...55 °C for horizontal installation -10...35 °C for vertical installation
ambient air temperature for storage	-25...70 °C
relative humidity	10...95 % without condensation in operation 10...95 % without condensation in storage
IP degree of protection	IP20 with protective cover in place
pollution degree	<= 2
operating altitude	0...2000 m
storage altitude	0...3000 m
vibration resistance	<p>3.5 mm (vibration frequency: 5...8.4 Hz) on symmetrical rail</p> <p>1 gn (vibration frequency: 8.4...150 Hz) on symmetrical rail</p> <p>3.5 mm (vibration frequency: 5...8.4 Hz) on panel mounting</p> <p>1 gn (vibration frequency: 8.4...150 Hz) on panel mounting</p>
shock resistance	98 m/s <sup>2</sup> (test wave duration: 11 ms)

## Offer Sustainability

Green Premium product	Green Premium product
Compliant - since 1415 - Schneider Electric declaration of conformity	Compliant - since 1415 - Schneider Electric declaration of conformity
Reference not containing SVHC above the threshold	Reference not containing SVHC above the threshold
Available	Available
Available	Available

## Dimensions

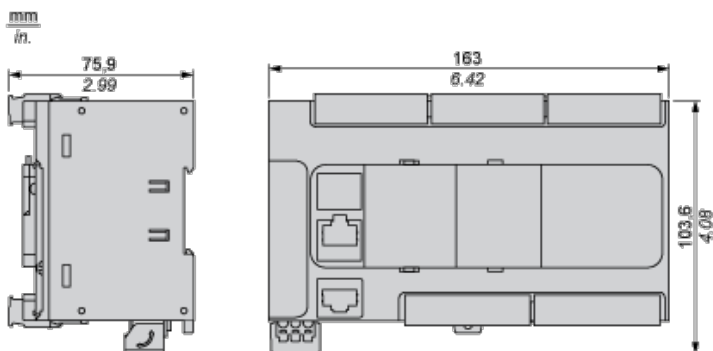

## Mounting on a Rail

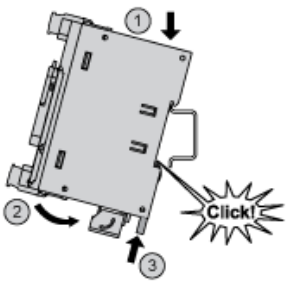

## Direct Mounting on a Panel Surface

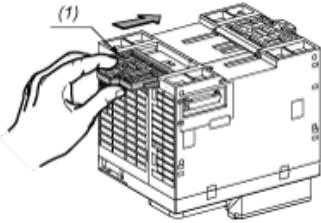

(1) Install a mounting strip

### Mounting Hole Layout

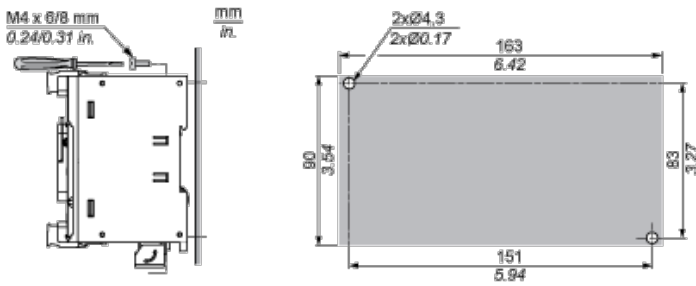

## Mounting

### Correct Mounting Position

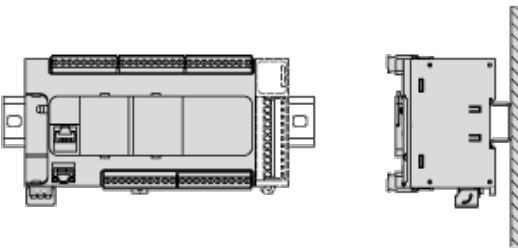

### Acceptable Mounting Position

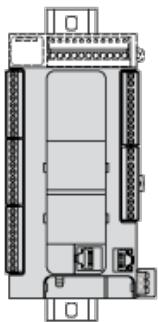

### Incorrect Mounting Position

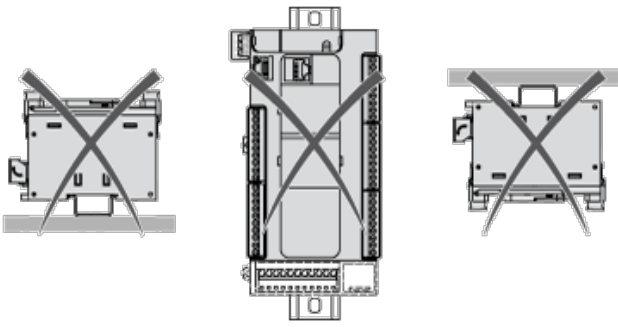

## Clearance

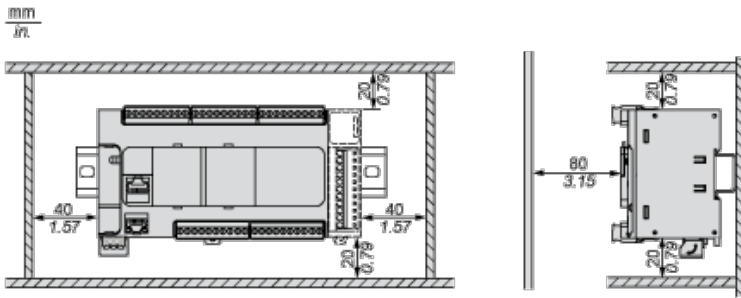

## Digital Inputs

### Wiring Diagram (Positive Logic)

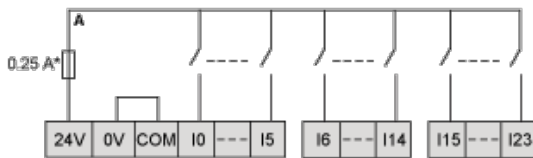

(\*) Type T fuse

### Wiring Diagram (Negative Logic)

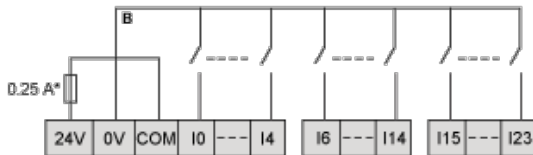

(\*) Type T fuse

### Connection of the Fast Inputs

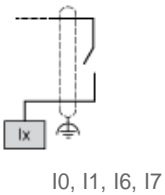

## Relay Outputs

### Negative Logic (Sink)

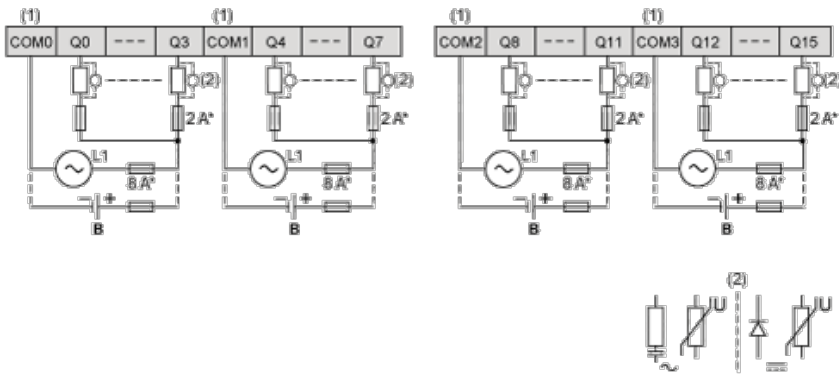

(\*) Type T fuse

(1) The COM0, COM1, COM2 and COM3 terminals are not connected internally.

(2) To improve the life time of the contacts, and to protect from potential inductive load damage, you must connect a free wheeling diode in parallel to each inductive DC load or an RC snubber in parallel of each inductive AC load

B Sink wiring (negative logic)

### Positive Logic (Source)

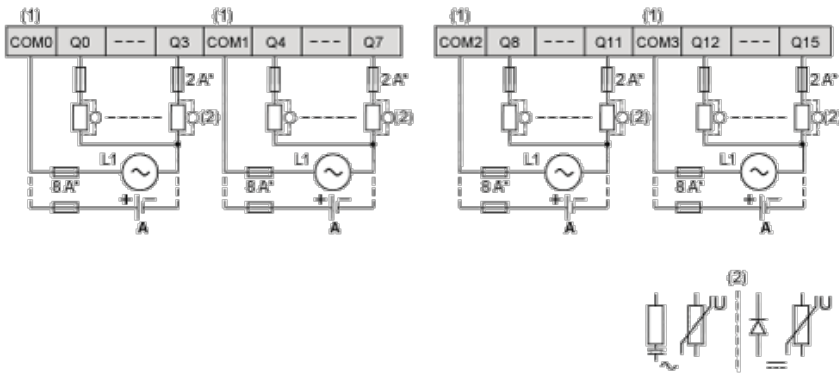

(\*) Type T fuse

(1) The COM0, COM1, COM2 and COM3 terminals are not connected internally.

(2) To improve the life time of the contacts, and to protect from potential inductive load damage, you must connect a free wheeling diode in parallel to each inductive DC load or an RC snubber in parallel of each inductive AC load

A Source wiring (positive logic)

### Analog Inputs

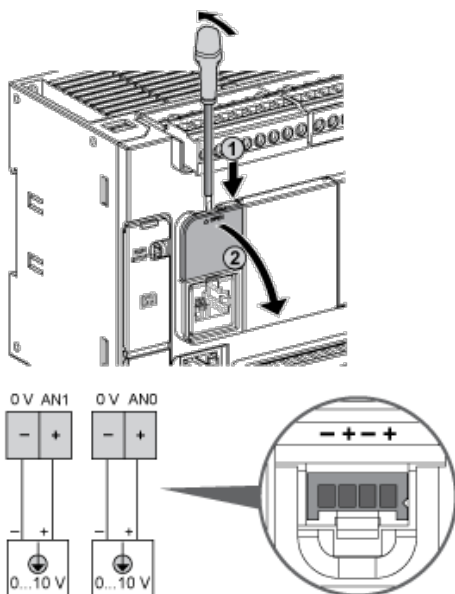

The (-) poles are connected internally.

Pin	Wire Color
0 V	Black

AN1	Red
0 V	Black
AN0	Red

## Ethernet Connection

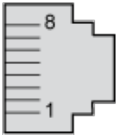

Pin N°	Signal
1	TD+
2	TD-
3	RD+
4	-
5	-
6	RD-
7	-
8	-

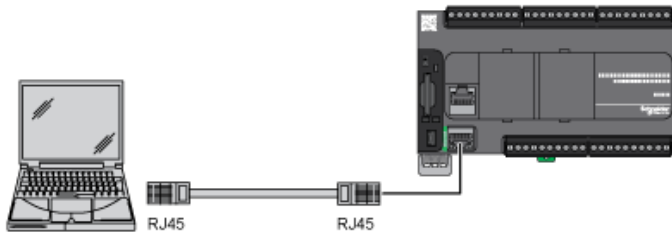

## USB Mini-B Connection

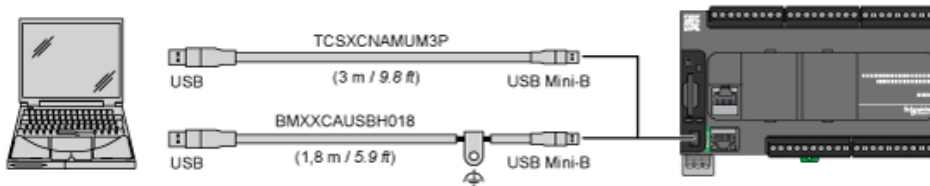

## SL1 Connection

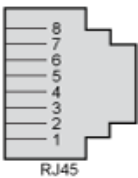

SL1

N °	RS 232	RS 485
1	RxD	N.C.
2	TxD	N.C.
3	RTS	N.C.
4	N.C.	D1



5	N.C.	D0
6	CTS	N.C.
7	N.C.*	5 Vdc
8	Common	Common

N.C.: not connected

\* : 5 Vdc delivered by the controller. Do not connect.

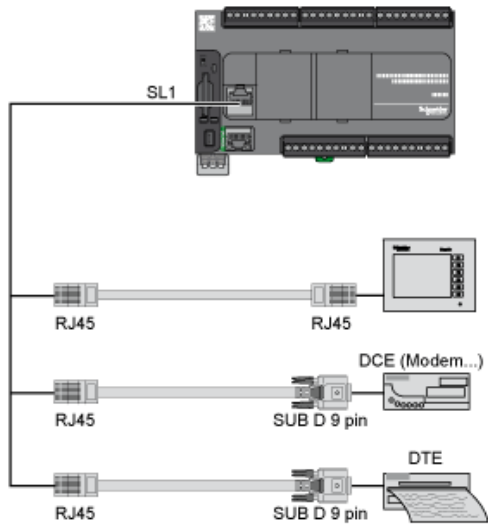

## Derating Curves

### Embedded Digital Inputs (No Cartridge)

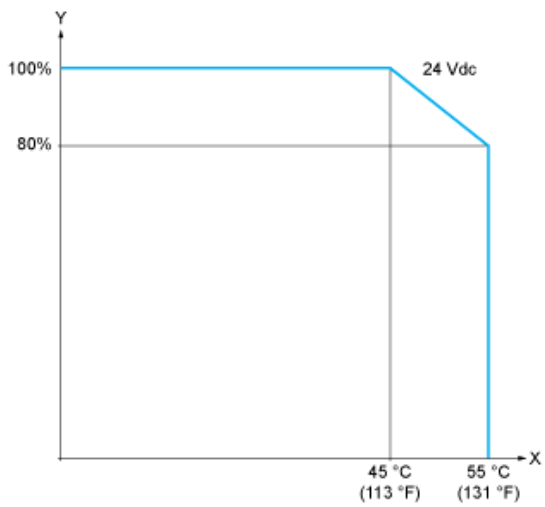

X : Ambient temperature

Y : Input simultaneous ON ratio

### Embedded Digital Inputs (with Cartridge)

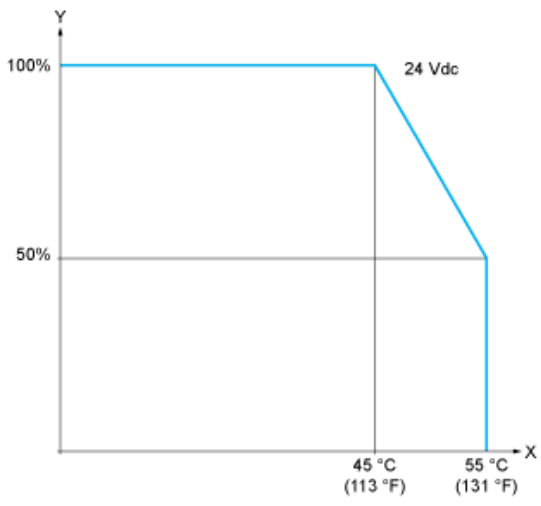

X : Ambient temperature

Y : Input simultaneous ON ratio