



Glavno

Range of product	Modicon M221
Product or component type	Logic controller
[Us] rated supply voltage	24 V DC
Discrete input number	14 discrete input conforming to IEC 61131-2 Type 1 including 4 fast input
Analogue input number	2 at input range: 0...10 V
Discrete output type	Transistor
Discrete output number	10 transistor including 2 fast output
Discrete output voltage	24 V DC
Discrete output current	0.5 A

Komplementarno

Discrete I/O number	24
Number of I/O expansion module	<= 7for transistor output <= 7for relay output
Supply voltage limits	20.4...28.8 V
Inrush current	<= 35 A
Power consumption in W	<= 13 W at 24 V with max number of I/O expansion module <= 4.1 W at 24 V without I/O expansion module
Power supply output current	0.52 A at 5 Vfor expansion bus 0.2 A at 24 Vfor expansion bus
Discrete input logic	Sink or source (positive/negative)
Discrete input voltage	24 V
Discrete input voltage type	DC
Analogue input resolution	10 bits
LSB value	10 mV
Conversion time	1 ms per channel + 1 controller cycle timefor analog input
Permitted overload on inputs	+/- 30 V DCfor analog input with 5 min maximum +/- 13 V DCfor analog input permanent
Voltage state 1 guaranteed	>= 15 Vfor input
Voltage state 0 guaranteed	<= 5 Vfor input
Discrete input current	7 mAfor discrete input 5 mAfor fast input
Input impedance	4.9 kOhmfor fast input 3.4 kOhmfor discrete input 100 kOhmfor analog input
Response time	35 µs turn-off operationfor input; I2...I5 terminal 5 µs turn-on operationfor fast input; I0, I1, I6, I7 terminal 35 µs turn-on operationfor input; other terminals terminal 5 µs turn-off operationfor fast input; I0, I1, I6, I7 terminal 100 µs turn-off operationfor input; other terminals terminal 5 µs turn-on, turn-off operationfor output; Q0...Q1 terminal 50 µs turn-on, turn-off operationfor output; Q2...Q3 terminal 300 µs turn-on, turn-off operationfor output; other terminals terminal
Configurable filtering time	0 msfor input 12 msfor input 3 msfor input
Discrete output logic	Positive logic (source)
Current per output common	5 A
Output frequency	100 kHzfor fast output (PWM/PLS mode) at Q0...Q1 terminal 5 kHzfor output at Q2...Q3 terminal

Informacije dane u ovoj dokumentaciji sadrže opće opise i/ili tehničke karakteristike o performansama ovdje sadržanih proizvoda.
 Ova dokumentacija nije namijenjena kao zamjena za niti bi se trebala koristiti za određivanje prikladnosti ili pouzdanosti predmetnih proizvoda za konkretne korisničke primjene.
 Svaki takav korisnik ili integrator dužan je provesti odgovarajuću i potpunu analizu rizika, procjenu i ispitivanje proizvoda u odnosu na odgovarajuću specifičnu primjenu ili uporabu istog.
 Niti društvo Schneider Electric Industries SAS niti bilo koje od njegovih povezanih poduzeća ili podružnica neće preuzeti obvezu ili snositi odgovornost za pogrešnu upotrebu ovdje sadržanih informacija.

	0.1 kHzfor output at Q4...Q9 terminal
Absolute accuracy error	+/- 1 % of full scalefor analog input
Leakage current	0.1 mAfor transistor output
Voltage drop	<= 1 V
Mechanical durability	>= 20000000 cyclesfor transistor output
Tungsten load	<= 12 Wfor output and fast output
Protection type	Overload and short-circuit protection at 1 A
Reset time	1 s automatic reset
Memory capacity	256 kBfor user application and data RAM with 10000 instructions 256 kBfor internal variables RAM
Data backed up	256 kB built-in flash memoryfor backup of application and data
Data storage equipment	2 GB SD card optional
Battery type	BR2032 lithium non-rechargeable, battery life: 4 yr
Backup time	1 year at 25 °C by interruption of power supply
Execution time for 1 KInstruction	0.3 msfor event and periodic task
Execution time per instruction	0.2 µs Boolean
Exct time for event task	60 µs response time
Maximum size of object areas	512 %M memory bits 8000 %MW memory words 512 %KW constant words 255 %TM timers 255 %C counters
Realtime clock	With
Clock drift	<= 30 s/month at 25 °C
Regulation loop	Adjustable PID regulator up to 14 simultaneous loops
Positioning functions	Position PTO 2 axe(s) pulse/direction mode (100 kHz) Position PTO 1 axe(s) CW/CCW mode (100 kHz)
Function available	PWM PLS Frequency generator
Counting input number	4 fast input (HSC mode) (counting frequency: 100 kHz), counting capacity: 32 bits
Control signal type	A/B Pulse/direction Single phase
Integrated connection type	USB port with connector mini B USB 2.0 Non isolated serial link "serial 1" with connector RJ45 and interface RS485 Non isolated serial link "serial 2" with connector RJ45 and interface RS232/RS485
Supply	Serial serial link supply at 5 V 200 mA
Transmission rate	1.2...115.2 kbit/s (115.2 kbit/s by default) for bus length of 15 m - communication protocol: RS485 1.2...115.2 kbit/s (115.2 kbit/s by default) for bus length of 3 m - communication protocol: RS232 480 Mbit/s - communication protocol: USB
Communication port protocol	USB port: USB protocol - SoMachine-Network Non isolated serial link: Modbus protocol master/slave - RTU/ASCII or SoMachine-Network
Local signalling	1 LED red for module error (ERR) 1 LED green for PWR 1 LED green for RUN 1 LED greenfor SD card access (SD) 1 LED redfor BAT 1 LED greenfor SL1 1 LED greenfor SL2 1 LED per channel greenfor I/O state
Electrical connection	Mini B USB 2.0 connector for a programming terminal Terminal block, 3 terminal(s) for connecting the 24 V DC power supply Connector, 4 terminal(s) for analogue inputs Removable screw terminal block for inputs Removable screw terminal block for outputs
Cable distance between devices	Shielded cable: 10 mfor fast input Unshielded cable: 30 mfor output Unshielded cable: 30 mfor digital input Unshielded cable: 1 mfor analog input Shielded cable: 3 mfor fast output
Insulation	500 V AC between fast input and internal logic Non-insulated between inputs

Non-insulated between analogue inputs
 500 V AC between output and internal logic
 500 V AC between input and internal logic
 Non-insulated between analogue input and internal logic

Marking	CE
Mounting support	Top hat type TH35-15 rail conforming to IEC 60715 Top hat type TH35-7.5 rail conforming to IEC 60715 Plate or panel with fixing kit
Height	90 mm
Depth	70 mm
Width	110 mm
Product weight	0.395 kg

Okolina

standards	EN/IEC 60664-1 EN/IEC 61131-2 EN/IEC 61010-2-201
product certifications	ABS CSA CULus LR IACS E10 RCM EAC DNV-GL
environmental characteristic	Ordinary and hazardous location
resistance to electrostatic discharge	4 kV on contact conforming to EN/IEC 61000-4-2 8 kV in air conforming to EN/IEC 61000-4-2
resistance to electromagnetic fields	10 V/m (80 MHz...1 GHz) conforming to EN/IEC 61000-4-3 3 V/m (1.4 GHz...2 GHz) conforming to EN/IEC 61000-4-3 1 V/m (2...2.7 GHz) conforming to EN/IEC 61000-4-3
resistance to magnetic fields	30 A/m 50/60 Hz conforming to EN/IEC 61000-4-8
resistance to fast transients	2 kVfor power lines conforming to EN/IEC 61000-4-4 2 kVfor relay output conforming to EN/IEC 61000-4-4 1 kVfor Ethernet line conforming to EN/IEC 61000-4-4 1 kVfor serial link conforming to EN/IEC 61000-4-4 1 kVfor I/O conforming to EN/IEC 61000-4-4
surge withstand	2 kVfor power lines (AC) in common mode conforming to EN/IEC 61000-4-5 2 kVfor relay output in common mode conforming to EN/IEC 61000-4-5 1 kVfor I/O in common mode conforming to EN/IEC 61000-4-5 1 kVfor shielded cable in common mode conforming to EN/IEC 61000-4-5 0.5 kVfor power lines (DC) in differential mode conforming to EN/IEC 61000-4-5 1 kVfor power lines (AC) in differential mode conforming to EN/IEC 61000-4-5 1 kVfor relay output in differential mode conforming to EN/IEC 61000-4-5 0.5 kVfor power lines (DC) in common mode conforming to EN/IEC 61000-4-5
resistance to conducted disturbances	10 Vrms (0.15...80 MHz) conforming to EN/IEC 61000-4-6 3 Vrms (0.1...80 MHz) conforming to Marine specification (LR, ABS, DNV, GL) 10 Vrms (spot frequency (2, 3, 4, 6.2, 8.2, 12.6, 16.5, 18.8, 22, 25 MHz)) conforming to Marine specification (LR, ABS, DNV, GL)
electromagnetic emission	Conducted emissionsconforming to EN/IEC 55011 power lines (AC), 0.15...0.5 MHz : 79 dB μ V/m QP/66 dB μ V/m AV Conducted emissionsconforming to EN/IEC 55011 power lines (AC), 0.5...300 MHz : 73 dB μ V/m QP/60 dB μ V/m AV Conducted emissionsconforming to EN/IEC 55011 power lines, 10...150 kHz : 120...69 dB μ V/m QP Conducted emissionsconforming to EN/IEC 55011 power lines, 1.5...30 MHz : 63 dB μ V/m QP Radiated emissionsconforming to EN/IEC 55011 class A 10 m, 30...230 MHz : 40 dB μ V/m QP Conducted emissions conforming to EN/IEC 55011 power lines, 150...1500 kHz: 79...63 dB μ V/m QP Radiated emissions conforming to EN/IEC 55011 class A 10 m, 200...1000 MHz: 47 dB μ V/m QP
immunity to microbreaks	10 ms
ambient air temperature for operation	-10...55 °C for horizontal installation -10...35 °Cfor vertical installation
ambient air temperature for storage	-25...70 °C
relative humidity	10...95 % without condensation in operation 10...95 % without condensation in storage

IP degree of protection	IP20 with protective cover in place
pollution degree	<= 2
operating altitude	0...2000 m
storage altitude	0...3000 m
vibration resistance	3.5 mm (vibration frequency: 5...8.4 Hz) on symmetrical rail 1 gn (vibration frequency: 8.4...150 Hz) on symmetrical rail 3.5 mm (vibration frequency: 5...8.4 Hz) on panel mounting 1 gn (vibration frequency: 8.4...150 Hz) on panel mounting
shock resistance	147 m/s ² (test wave duration:11 ms)

Offer Sustainability

Green Premium product	Green Premium product
Compliant - since 1415 - Schneider Electric declaration of conformity	Compliant - since 1415 - Schneider Electric declaration of conformity
Reference not containing SVHC above the threshold	Reference not containing SVHC above the threshold
Available	Available
Available	Available

Dimensions

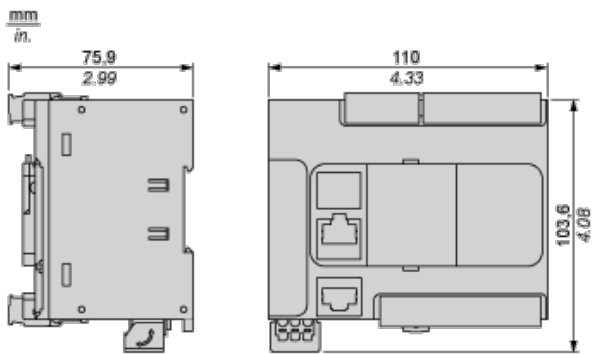

Mounting on a Rail

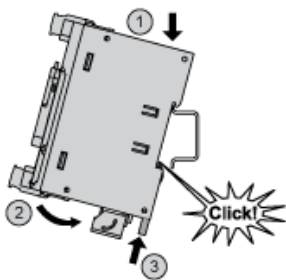

Direct Mounting on a Panel Surface

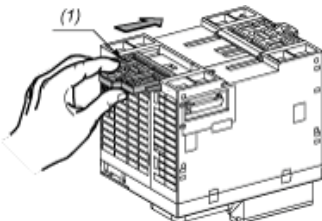

(1) Install a mounting strip

Mounting Hole Layout

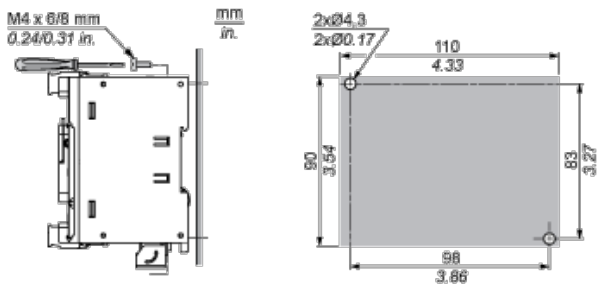

Mounting

Correct Mounting Position

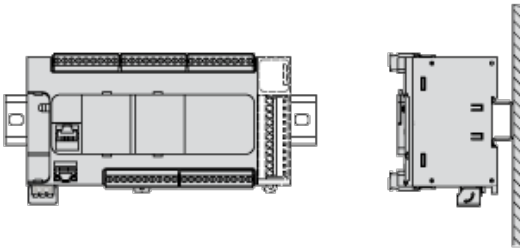

Acceptable Mounting Position

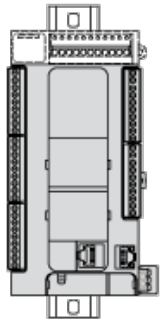

Incorrect Mounting Position

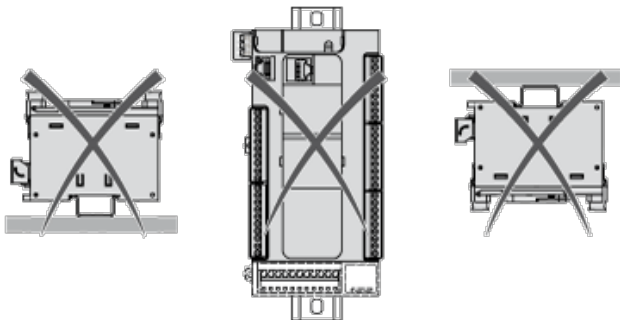

Clearance

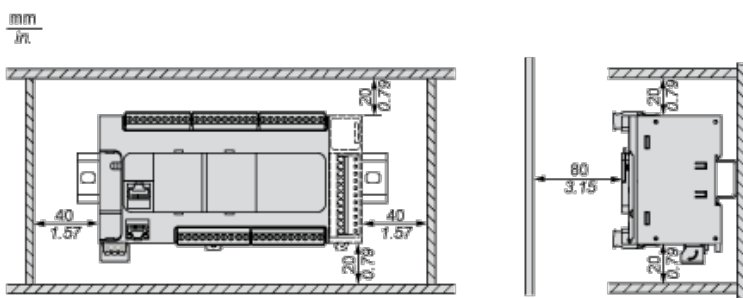

Digital Inputs

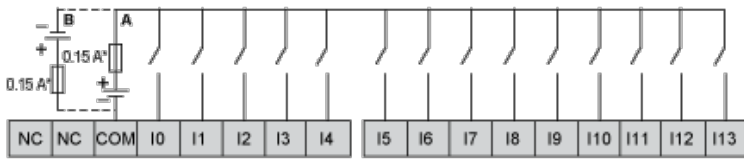

- (*) Type T fuse
- (A) Sink wiring (positive logic).
- (B) Source wiring (negative logic).

Connection of the Fast Inputs

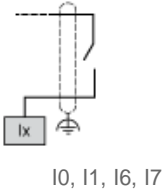

Transistor Outputs

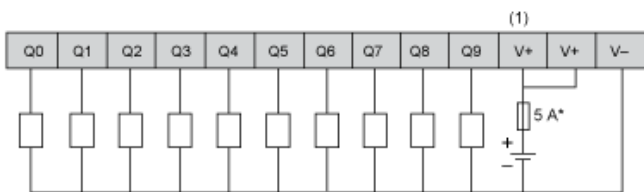

- (*) Type T fuse
- (1) The V+ terminals are connected internally.

Connection of the Fast Outputs

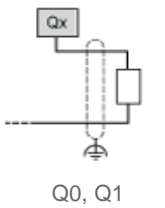

Analog Inputs

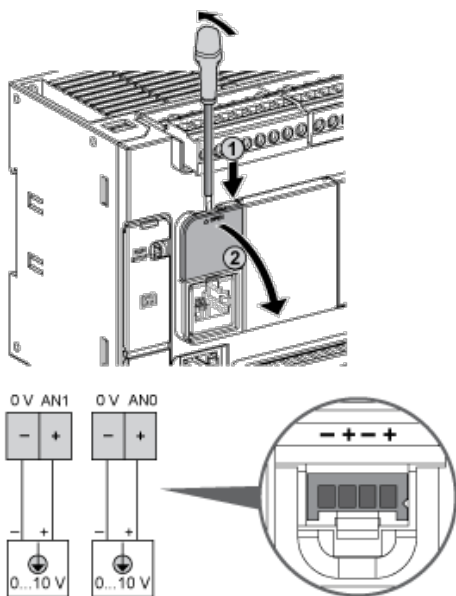

The (-) poles are connected internally.

Pin	Wire Color
0 V	Black

AN1	Red
0 V	Black
AN0	Red

USB Mini-B Connection

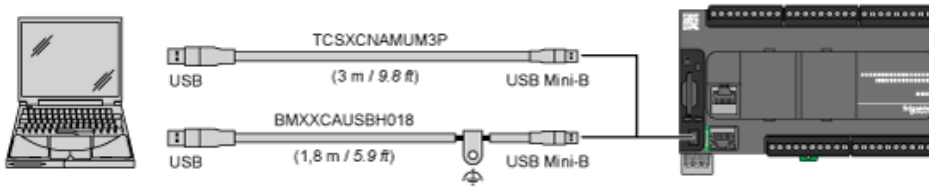

SL1 Connection

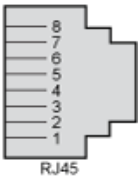

SL1

N °	RS 232	RS 485
1	RxD	N.C.
2	TxD	N.C.
3	RTS	N.C.
4	N.C.	D1
5	N.C.	D0
6	CTS	N.C.
7	N.C.*	5 Vdc
8	Common	Common

N.C.: not connected

* : 5 Vdc delivered by the controller. Do not connect.

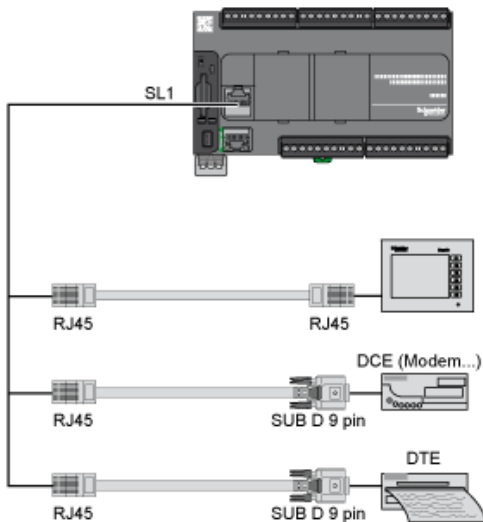

SL2 Connection

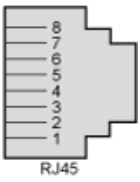

RJ45

N °	RS 485
1	N.C.
2	N.C.
3	N.C.
4	D1
5	D0
6	N.C.
7	N.C.
8	Common

N.C.: not connected

Derating Curves

Embedded Digital Inputs (No Cartridge)

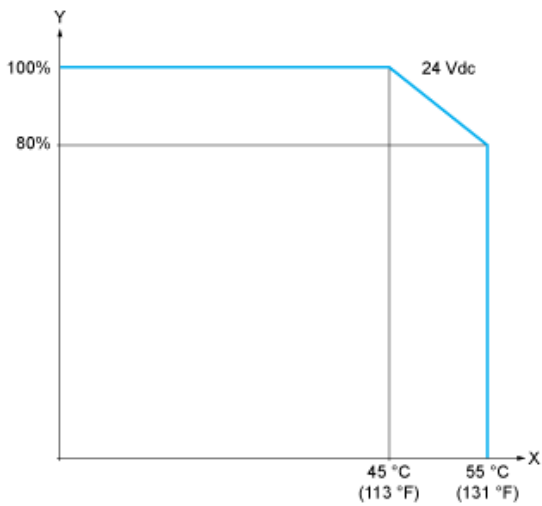

X : Ambient temperature

Y : Input simultaneous ON ratio

Embedded Digital Inputs (with Cartridge)

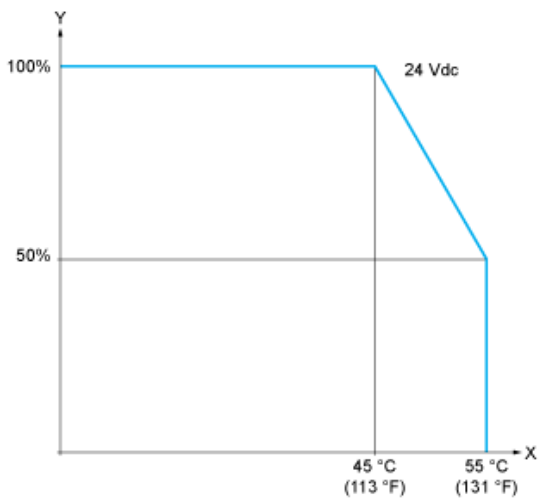

X : Ambient temperature

Y : Input simultaneous ON ratio

Derating Curves

Embedded Digital Outputs (No Cartridge)

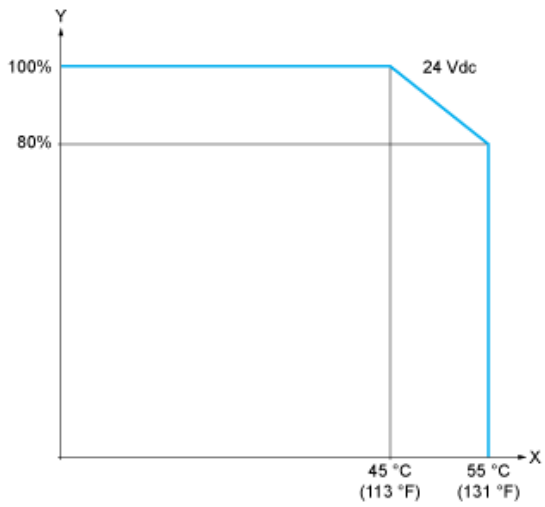

X : Ambient temperature

Y : Output simultaneous ON ratio

Embedded Digital Outputs (with Cartridge)

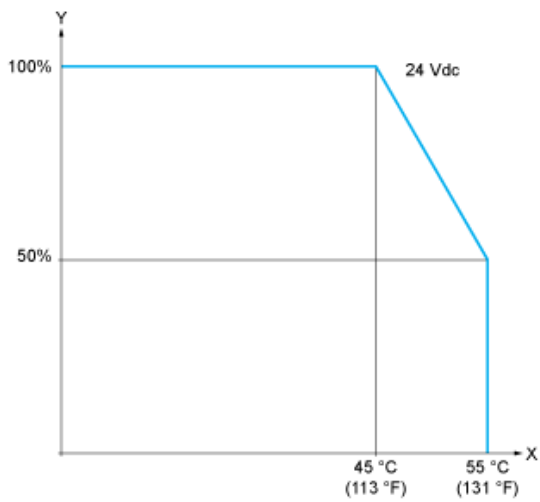

X : Ambient temperature

Y : Output simultaneous ON ratio