

SSP1A475M7

beskontaktni relej - montažna ploča - ulaz 90-280VAC, izlaz 48-660 VAC, 75 A



Glavno

Range of product	Zelio Relay
Product or component type	Solid state relay
Device short name	SSP1
Mounting support	Panel
Network number of phases	1 phase
Contacts type and composition	1 NO
[In] rated current	75 A
Solid state output type	Zero voltage switching SCR output

Komplementarno

[Uc] control circuit voltage	90...280 V AC
Minimum switching voltage	90 V AC turn-on
Maximum switching voltage	10 V AC turn-off
Response time	30 ms turn-off 25 ms turn-on
Input current limits	5...10 mA
Output voltage	48...660 V AC
Load current	0.15...75 A
Absolute maximum voltage	1200 V
Surge current	<= 1000 A for 16.6 ms
Maximum I ² t for fusing	4150 A ² .s for 8.33 ms at 60 Hz half cycle 4555 A ² .s for 10 ms at 50 Hz half cycle
Protection device type	Type 1 - 50 A miniature circuit breaker (MCB) - curve B Type 2 - 40 A miniature circuit breaker (MCB) - curve B
Leakage current	<= 1 mA off-state
Voltage drop	1.15 V on-state
DV/dt	500 V/μs off-state at maximum voltage
Cos phi	0.5 with maximum load
Motor power hp	1.5 hp 120 V AC 3 hp 240 V AC 7.5 hp 480 V AC
Insulation resistance	1000 MOhm at 500 V DC
Capacitance unbalance	8 pF for input/output
Dielectric strength	4 kV AC for input/output 4 kV AC for input or output to case
[Uimp] rated impulse withstand voltage	6 kV output to case 6 kV input to output
Tightening torque	1.5...1.7 N.m for input 2...2.2 N.m for output
Connections - terminals	Forked type tag connectors : 9.2 x 4 mm for input Ring lugs : 9.2 x 4 mm for input Forked type tag connectors : 11.7 x 4.5 mm for output Ring lugs : 11.7 x 4.5 mm for output Screw terminals : 0.2...3.3 mm ² , (AWG 24...AWG 12) with cable end for input Screw terminals : 0.5...5.26 mm ² , (AWG 20...AWG 10) with cable end for output Screw terminals : 0.2...3.3 mm ² , (AWG 24...AWG 12) without cable end for input Screw terminals : 0.5...8.26 mm ² , (AWG 20...AWG 8) without cable end for output
Thermal resistance	0.3 °C/W junction to case

Informacije dane u ovoj dokumentaciji sadrže opće i/ili tehničke karakteristike o performansama ovdje sadržanih proizvoda. Ova dokumentacija nije namijenjena kao zamjena za niti bi se trebala koristiti za određivanje prikladnosti ili pouzdanosti predmetnih proizvoda za konkretne korisničke primjene. Svaki takav korisnik ili integrator dužan je provesti odgovarajuću i potpunu analizu rizika, procjenu i ispitivanje proizvoda u odnosu na odgovarajuću specifičnu primjenu ili uporabu istog. Niti društvo Schneider Electric Industries SAS niti bilo koje od njegovih povezanih podružnica neće preuzeti obvezu ili snositi odgovornost za pogrešnu upotrebu ovdje sadržanih informacija.

Local signalling	LED, greenfor input
IP degree of protection	IP20
Safety reliability data	MTTFd = 1875.9 years B10d = 1731395
Product weight	89.2 g

Okolina

ambient air temperature for operation	-40...80 °C
ambient air temperature for storage	-40...125 °C
pollution degree	2
overvoltage category	III
product certifications	CE CSA RoHS UL REACH EAC
marking	CE CSA UL EAC
standards	EN/IEC 60950-1 UL 508 EN/IEC 62314 CSA C22.2 No 14-13

Offer Sustainability

Green Premium product	Green Premium product
Compliant - since 1522 - Schneider Electric declaration of conformity	Compliant - since 1522 - Schneider Electric declaration of conformity
Reference not containing SVHC above the threshold	Reference not containing SVHC above the threshold
Available	Available
Available	Available

Dimensions

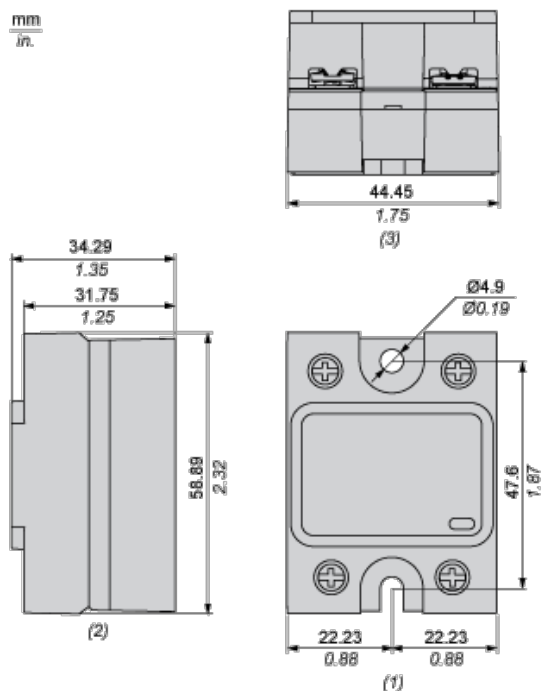

- (1) Front view
- (2) Side view
- (3) Bottom view

Derating Curves

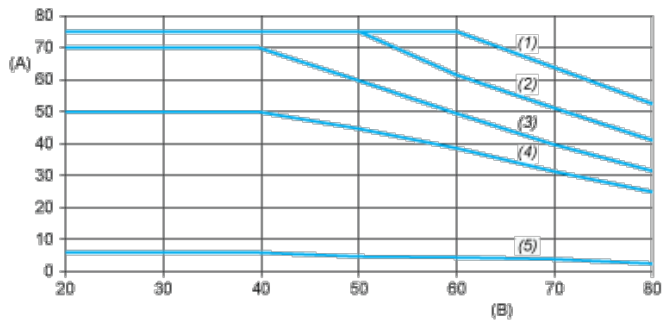

A : Load Current (Arms)

B : Ambient Temperature (°C)

(1) For Heatsink SSRHP02

(2) For Heatsink SSRHP05

(3) For Heatsink SSRHP07

(4) For Heatsink SSRHD10

(5) No Heatsink