

## GV3L65

TeSys GV3 – Prekidači – magnetski – 65 A – konektori EverLink BTR



### Glavno

Range	TeSys
Product name	TeSys GV3
Device short name	GV3L
Product or component type	Circuit breaker
Device application	Motor
Poles description	3P
Network type	AC
Utilisation category	AC-3 conforming to IEC 60947-4-1 Category A conforming to IEC 60947-2
Network frequency	50/60 Hz
Breaking capacity	50 kA Icu at 440 V AC 50/60 Hz 100 kA Icu at 230/240 V AC 50/60 Hz 12 kA Icu at 500 V AC 50/60 Hz 6 kA Icu at 690 V AC 50/60 Hz 50 kA Icu at 400/415 V AC 50/60 Hz
[Ics] rated service short-circuit breaking capacity	50 %at 500 V AC 50/60 Hz 50 %at 690 V AC 50/60 Hz 100 %at 230/240 V AC 50/60 Hz 100 %at 400/415 V AC 50/60 Hz 100 %at 440 V AC 50/60 Hz
Trip unit technology	Magnetic
Magnetic tripping current	910 A

### Komplementarno

Fixing mode	Clipped on 35 mm symmetrical DIN rail Screwed on panel (with 3 x M4 screws)
Operating position	Any position
Motor power kW	37 kW at 500 V AC 50/60 Hz 55 kW at 690 V AC 50/60 Hz 30 kW at 400/415 V AC 50/60 Hz
Control type	Rotary knob
[Ue] rated operational voltage	690 V AC 50/60 Hz conforming to IEC 60947-2
[Ui] rated insulation voltage	690 V AC 50/60 Hz conforming to IEC 60947-2
[Uimp] rated impulse withstand voltage	6 kV conforming to IEC 60947-2
Mechanical durability	50000 cycles
Electrical durability	50000 cycles for AC-3at 415 V
Operating rate	25 cyc/h
Connections - terminals	EverLink BTR screw connectors 2 cable(s) 1...25 mm <sup>2</sup> solid EverLink BTR screw connectors 2 cable(s) 1...25 mm <sup>2</sup> flexible without cable end EverLink BTR screw connectors 2 cable(s) 1...25 mm <sup>2</sup> flexible with cable end EverLink BTR screw connectors 1 cable(s) 1...35 mm <sup>2</sup> solid EverLink BTR screw connectors 1 cable(s) 1...35 mm <sup>2</sup> flexible without cable end EverLink BTR screw connectors 1 cable(s) 1...35 mm <sup>2</sup> flexible with cable end
Tightening torque	5 N.m on EverLink BTR screw connectors for cable 25 mm <sup>2</sup> 8 N.m on EverLink BTR screw connectors for cable 35 mm <sup>2</sup>
Mechanical robustness	Shocks closed 15 Gn for 11 ms conforming to IEC 60068-2-27 Shocks opened 30 Gn for 11 ms conforming to IEC 60068-2-27 Vibrations 4 Gn, 5...300 Hz conforming to IEC 60068-2-6
Suitability for isolation	Yes conforming to IEC 60947-1
Phase failure sensitivity	Yes

Informacije dane u ovoj dokumentaciji sadrže opće opisne i/ili tehničke karakteristike o performansama ovdje sadržanih proizvoda. Ova dokumentacija nije namijenjena kao zamjena za niti bi se trebala koristiti za određivanje prikladnosti ili pouzdanosti predmetnih proizvoda za konkretne korisničke primjene. Svaki takav korisnik ili integrator dužan je provesti odgovarajuću i potpunu analizu rizika, procjenu i ispitivanje proizvoda u odnosu na odgovarajuću specifičnu primjenu ili uporabu istog. Niti društvo Schneider Electric Industries SAS niti bilo koje od njegovih povezanih podružnica neće preuzeti obvezu ili snositi odgovornost za pogrešnu upotrebu ovdje sadržanih informacija.

Height	132 mm
Width	55 mm
Depth	136 mm
Product weight	0.96 kg

## Okolina

standards	EN/IEC 60947-1 EN/IEC 60947-2
product certifications	ABS BV CCC LRQS (Lloyds register of shipping) EAC DNV-GL
protective treatment	TH
IP degree of protection	IP20 conforming to IEC 60529
IK degree of protection	IK09
ambient air temperature for operation	-20...60 °C
ambient air temperature for storage	-40...80 °C
fire resistance	960 °C conforming to IEC 60695-2-1
operating altitude	0...3000 m

## Offer Sustainability

Green Premium product	Green Premium product
Compliant - since 0501 - Schneider Electric declaration of conformity	Compliant - since 0501 - Schneider Electric declaration of conformity
Reference not containing SVHC above the threshold	Reference not containing SVHC above the threshold
Available	Available
Need no specific recycling operations	Need no specific recycling operations

## Contractual warranty

Warranty period	18 months
-----------------	-----------

## Tripping Curves for GV3L Combined with Thermal Overload Relay LRD33

Average Operating time at 20 °C without Prior Current Flow

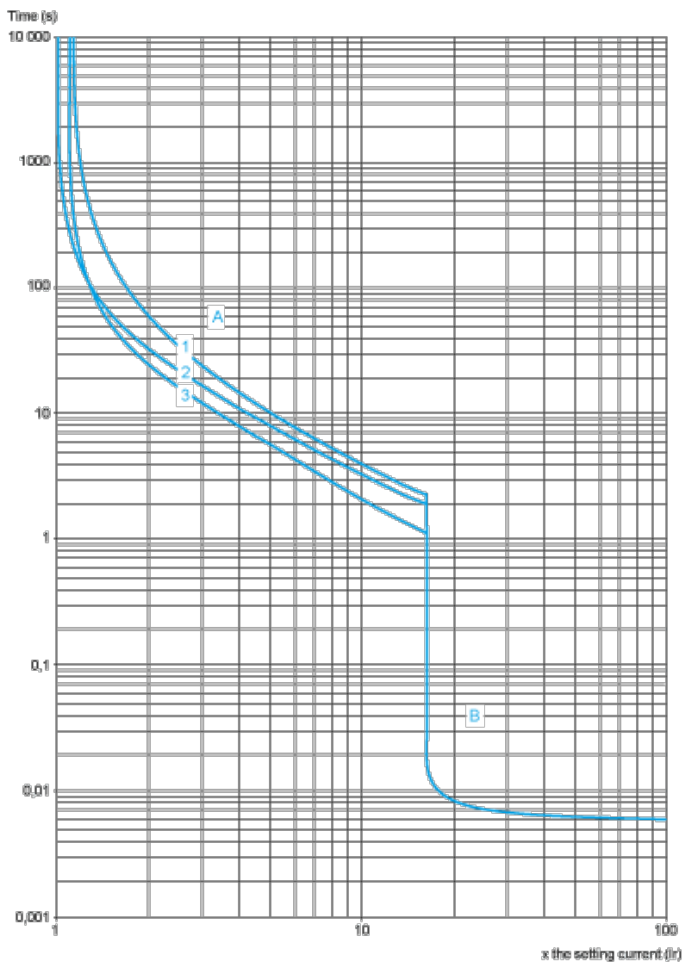

- 1 3 poles from cold state
- 2 2 poles from cold state
- 3 3 poles from hot state
- A Thermal overload relay protection zone
- B GV3L protection zone

**Current Limitation on Short-Circuit for GV3L (3-Phase 400/415 V)**

**Dynamic Stress**

$I_{peak} = f(\text{prospective } I_{sc}) \text{ at } 1.05 U_e = 435 \text{ V}$

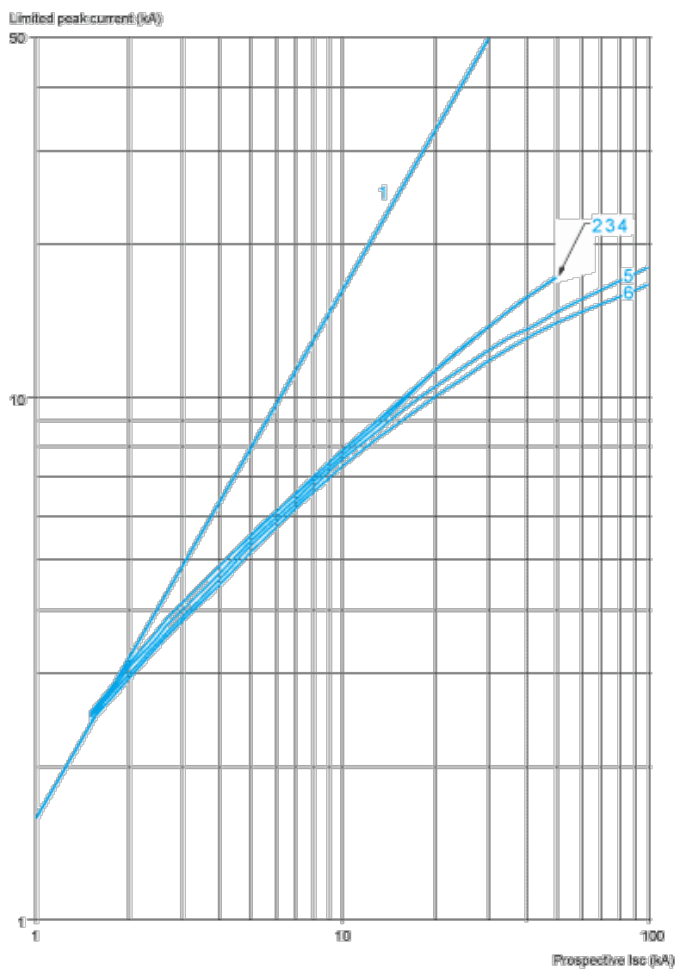

- 1 Maximum peak current
- 2 GV3L80 - GV3L73 - GV3L65
- 3 GV3L50
- 4 GV3L40
- 5 GV3L32
- 6 GV3L25

**Thermal Limit on Short-Circuit for GV3L**

**Thermal Limit in A<sup>2</sup>s**

Sum of  $I^2dt = f$  (prospective Isc) at 1.05 Ue = 435 V

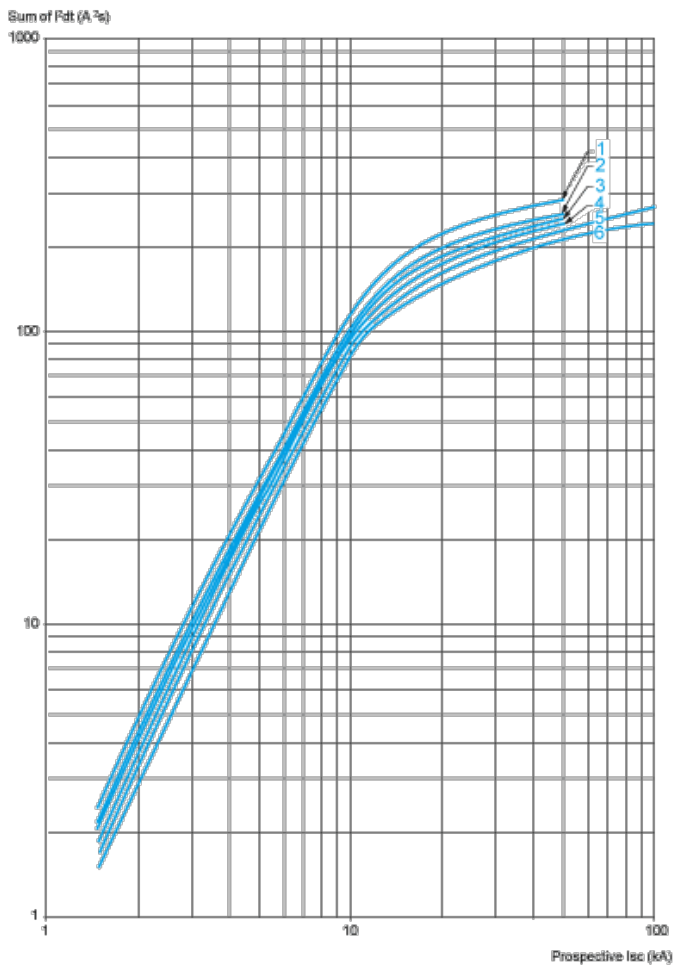

- 1 GV3L73 - GV3L80
- 2 GV3L65
- 3 GV3L50
- 4 GV3L40
- 5 GV3L32
- 6 GV3L25

### GV3L, GV3P

#### Dimensions

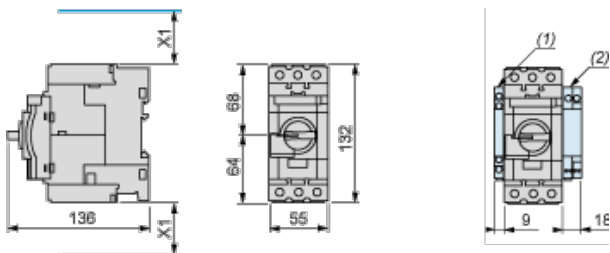

- (1) Blocks GVAN<sub>..</sub>, GVAD<sub>..</sub> and GVAM11.
- (2) Blocks GV3AU<sub>..</sub> and GV3AS<sub>..</sub>.

X1 = Electrical clearance (ISC max) 40 mm for  $U_e \leq 500$  V, 50 mm for  $U_e \leq 690$  V

**NOTE:** Leave a space of 9 mm between 2 circuit breakers: either an empty space or side-mounting add-on contact blocks. Side by side mounting is possible up to 40 °C.

Mounting with Tesys contactor LC1D40A...D80A and relay LR3D313...380 <sup>(1)(2)(3)</sup>

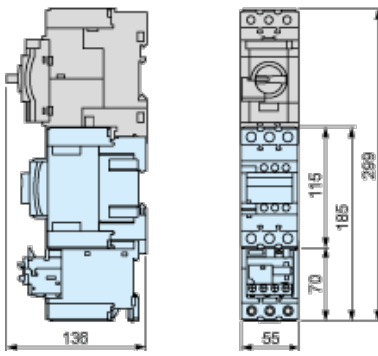

- (1) Mountings with c.b. up to GV3L73, GV3P73.
- (2) For GV3L80, GV3P80 use cable between components for dissipating heat. Consult online datasheets for values.
- (3) S-shape busbar system suitable up to 73 A.

**Side by side mounting with Tesys contactor LC1D40A...D73A (S-shape busbar system GV3S<sup>(1)</sup>)**

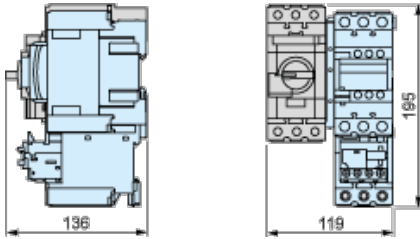

- (1) Mountings with c.b. up to GV3L73, GV3P73.

**Mounting on Rail AM1 DE200 or AM1 ED201**

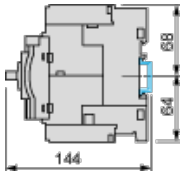

**Panel Mounting, using M4 Screws**

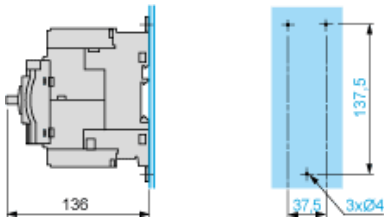

**Mounting on Pre-Slotted Plate AM1 PA**

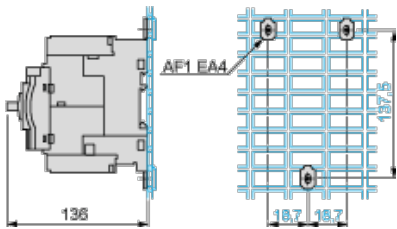

**Mounting of External Operator GV3APN01, GV3APN02 or GV3APN04 for Motor Circuit Breakers GV3L**

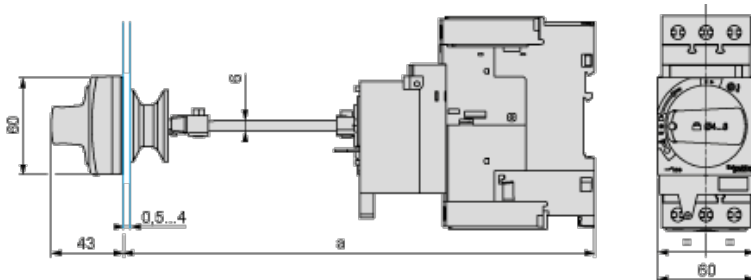

Door cut-out

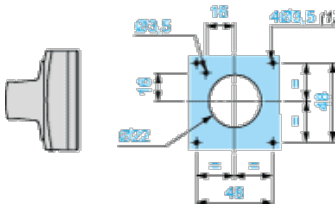

(1) For IP65 only.

### Mounting of External Operator GVAPH03 for Motor Circuit Breakers GV3L

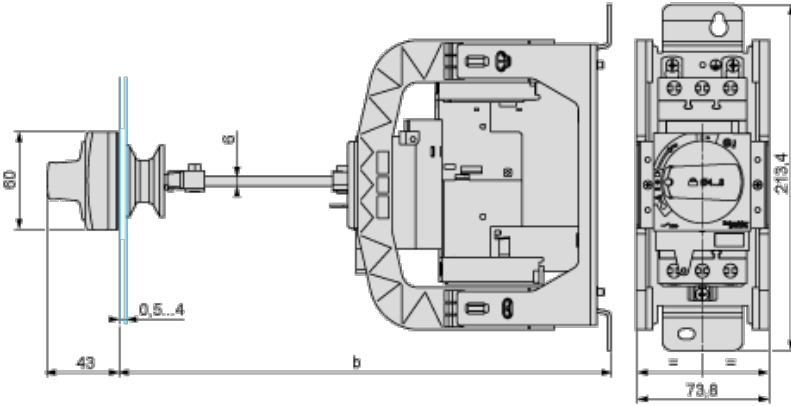

	b	
	Minimum	Maximum
GV3APN <sub>..</sub> + GVAPH03	200	300
GV3APN <sub>..</sub> + GVAPH03 + GVAPK12	300	492

Door cut-out

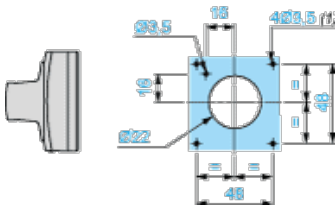

(1) For IP65 only.

### GV3L<sub>..</sub>

