

GV2L32

TeSys GV2 – Prekidači – magnetski – 32 A –
priključak vijčanim stezaljkama



Glavno

| | |
|---|---|
| Range | TeSys |
| Product name | TeSys GV2 |
| Device short name | GV2L |
| Product or component type | Circuit breaker |
| Device application | Motor |
| Poles description | 3P |
| Network type | AC |
| Utilisation category | AC-3 conforming to IEC 60947-4-1 Category A conforming to IEC 60947-2 |
| Network frequency | 50/60 Hz conforming to IEC 60947-2 |
| Breaking capacity | 10 kA Icu at 500 V AC 50/60 Hz conforming to IEC 60947-2 50 kA Icu at 230/240 V AC 50/60 Hz conforming to IEC 60947-2 20 kA Icu at 440 V AC 50/60 Hz conforming to IEC 60947-2 4 kA Icu at 690 V AC 50/60 Hz conforming to IEC 60947-2 50 kA Icu at 400/415 V AC 50/60 Hz conforming to IEC 60947-2 |
| [Ics] rated service short-circuit breaking capacity | 100 % at 230/240 V AC 50/60 Hz conforming to IEC 60947-2 100 % at 690 V AC 50/60 Hz conforming to IEC 60947-2 50 % at 400/415 V AC 50/60 Hz conforming to IEC 60947-2 75 % at 440 V AC 50/60 Hz conforming to IEC 60947-2 75 % at 500 V AC 50/60 Hz conforming to IEC 60947-2 |
| Trip unit technology | Magnetic |
| Magnetic tripping current | 416 A |

Komplementarno

| | |
|--|---|
| Fixing mode | Clipped on 35 mm symmetrical DIN rail Screwed on panel (with 2 x M4 screws) |
| Operating position | Any position |
| Motor power kW | 15 kW at 400/415 V AC 50/60 Hz 22 kW at 690 V AC 50/60 Hz 18.5 kW at 500 V AC 50/60 Hz |
| Control type | Rotary knob |
| [Ue] rated operational voltage | 690 V AC 50/60 Hz conforming to IEC 60947-2 |
| [Ui] rated insulation voltage | 690 V AC 50/60 Hz conforming to IEC 60947-2 |
| [Uimp] rated impulse withstand voltage | 6 kV conforming to IEC 60947-2 |
| Power dissipation per pole | 1.8 W |
| Mechanical durability | 100000 cycles |
| Electrical durability | 100000 cycles for AC-3 at 415 V |
| Operating rate | 40 cyc/h |
| Rated duty | Continuous conforming to IEC 60947-4-1 |
| Connections - terminals | Screw clamp terminals 2 cable(s) 1...6 mm ² solid Screw clamp terminals 2 cable(s) 1.5...6 mm ² flexible without cable end Screw clamp terminals 2 cable(s) 1...4 mm ² flexible with cable end |

Informacije dane u ovoj dokumentaciji sadrže opće tehničke karakteristike o performansama ovdje sadržanih proizvoda. Ova dokumentacija nije namijenjena kao zamjena za niti bi se trebala koristiti za određivanje prikladnosti ili pouzdanosti predmetnih proizvoda za konkretne korisničke primjene. Svaki takav korisnik ili integrator dužan je provesti odgovarajuću i poplunu analizu rizika, procjenu i ispitivanje proizvoda u odnosu na odgovarajuću specifičnu primjenu ili uporabu istog. Niti društvo Schneider Electric Industries SAS niti bilo koje od njegovih povezanih poduzeća ili podružnica neće preuzeti obvezu ili snositi odgovornost za pogrešku u potrošnji ovdje sadržanih informacija.

| | |
|---------------------------|--|
| Tightening torque | 1.7 N.m on screw clamp terminals |
| Mechanical robustness | Shocks 30 Gn conforming to IEC 60068-2-27 Vibrations 5 Gn, 5...150 Hz conforming to IEC 60068-2-6 |
| Suitability for isolation | Yes conforming to IEC 60947-1 |
| Phase failure sensitivity | Yes |
| Height | 89 mm |
| Width | 45 mm |
| Depth | 97 mm |
| Product weight | 0.33 kg |

Okolina

| | |
|---------------------------------------|---|
| standards | EN 60204 IEC 60947-1 IEC 60947-2 NF C 63-120 NF C 63-650 NF C 79-130 VDE 0113 VDE 0660 |
| product certifications | BV CCC CSA DNV GL LROS (Lloyds register of shipping) RINA |
| protective treatment | TH |
| IK degree of protection | IK04 |
| ambient air temperature for operation | -20...60 °C |
| ambient air temperature for storage | -40...80 °C |
| fire resistance | 960 °C conforming to IEC 60695-2-1 |
| operating altitude | 0...2000 m |

Offer Sustainability

| | |
|--|---|
| Green Premium product | Green Premium product |
| Compliant - since 0631 - Schneider Electric declaration of conformity | Compliant - since 0631 - Schneider Electric declaration of conformity |
| Reference contains SVHC above the threshold - go to CaP for more details | Reference contains SVHC above the threshold |
| Available | Available |
| Need no specific recycling operations | Need no specific recycling operations |

Contractual warranty

| | |
|-----------------|-----------|
| Warranty period | 18 months |
|-----------------|-----------|

Tripping Curves for GV2L or LE Combined with Thermal Overload Relay LRD or LR2K

Average Operating Times at 20 °C Related to Multiples of the Setting Current



- 1 3 poles from cold state
- 2 2 poles from cold state
- 3 3 poles from hot state

Current Limitation on Short-Circuit for GV2L and GV2LE Only (3-Phase 400/415 V)

Dynamic Stress

$I_{peak} = f(\text{prospective } I_{sc}) \text{ at } 1.05 U_e = 435 \text{ V}$

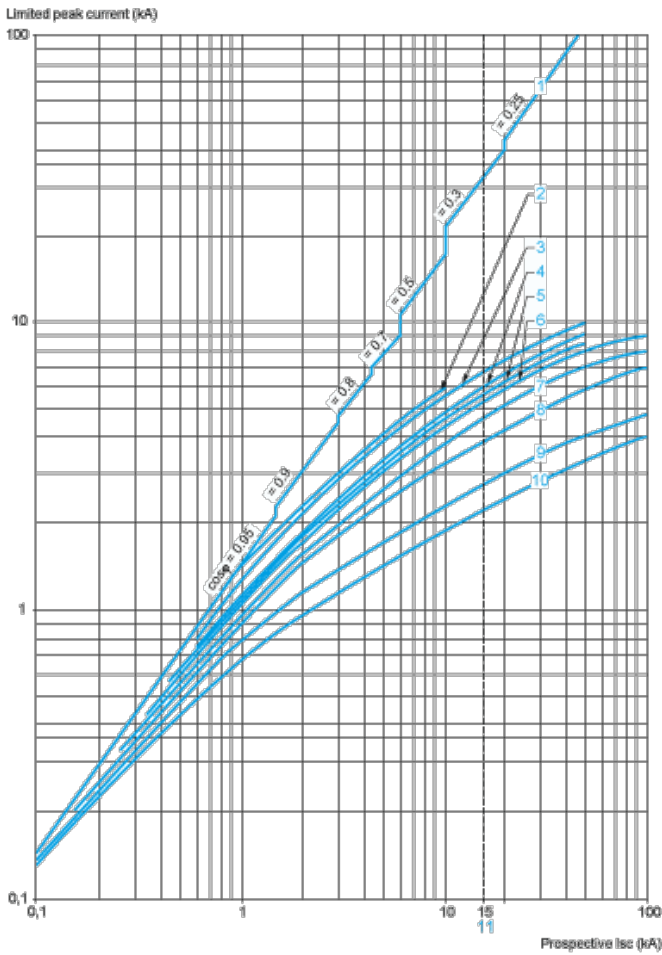

- 1 Maximum peak current
- 2 32 A
- 3 25 A
- 4 18 A
- 5 14 A
- 6 10 A
- 7 6.3 A
- 8 4 A
- 9 2.5 A
- 10 1.6 A
- 11 Limit of rated ultimate breaking capacity on short-circuit of GV2LE (14, 18, 23, and 25 A ratings).

Current Limitation on Short-Circuit for GV2L and GV2LE + Thermal Overload Relay LRD or LR2K (3-Phase 400/415 V)

Dynamic Stress

$I_{peak} = f(\text{prospective } I_{sc}) \text{ at } 1.05 U_e = 435 \text{ V}$



- 1 Maximum peak current
- 2 32 A
- 3 25 A
- 4 18 A
- 5 14 A
- 6 10 A
- 7 6.3 A
- 8 4 A
- 9 2.5 A
- 10 1.6 A
- 11 Limit of rated ultimate breaking capacity on short-circuit of GV2LE (14, 18, 23, and 25 A ratings).

Thermal Limit on Short-Circuit for GV2L Only

Thermal Limit in kA²s in the Magnetic Operating Zone

Sum of $I^2dt = f$ (prospective Isc) at 1.05 Ue = 435 V

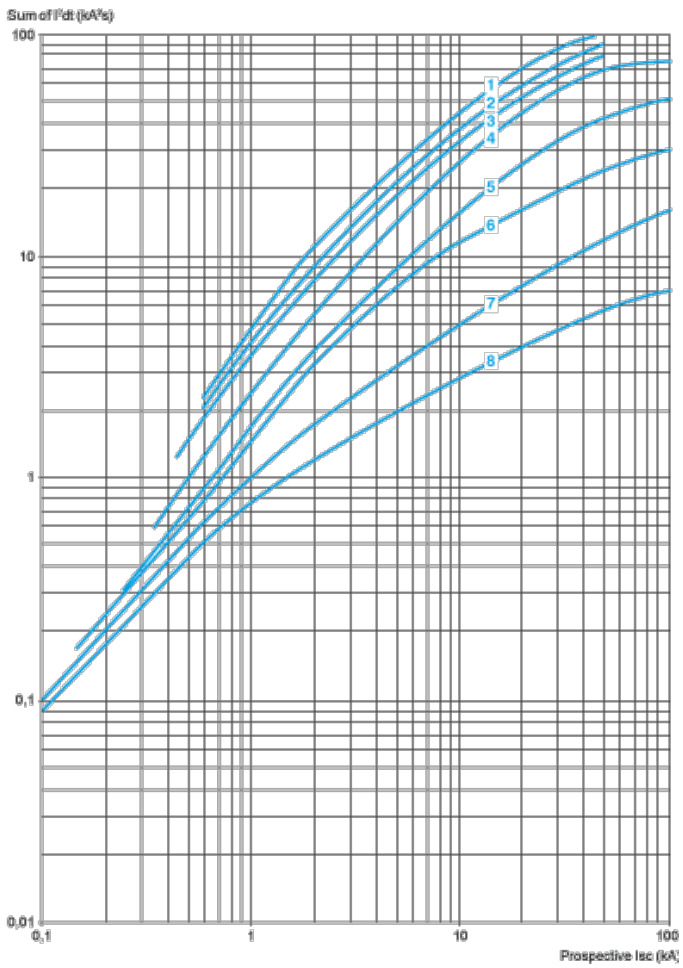

- 1 25 A and 32 A
- 2 18 A
- 3 14 A
- 4 10 A
- 5 6.3 A
- 6 4 A
- 7 2.5 A
- 8 1.6 A

Thermal Limit on Short-Circuit for GV2L and GV2LE + Thermal Overload Relay LRD or LR2K

Thermal Limit in kA²s in the Magnetic Operating Zone

Sum of $I^2dt = f$ (prospective Isc) at $1.05 U_e = 435 V$



- 1 32 A (GV2LE32)
- 2 25 A and 32 A (GV2L32)
- 3 18 A
- 4 14 A
- 5 10 A
- 6 6.3 A
- 7 4 A
- 8 2.5 A
- 9 1.6 A
- 10 Limit of rated ultimate breaking capacity on short-circuit of GV2 LE (14, 18, 23, and 25 A ratings).

GV2L

Dimensions

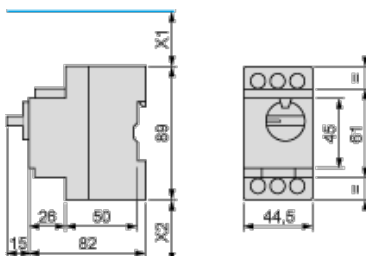

X1 Electrical clearance = 40 mm for $U_e \leq 415$ V, or 80 mm for $U_e = 440$ V, or 120 mm for $U_e = 500$ and 690 V.

X2 = 40 mm.

GVAD, AM, AN, AU, AS

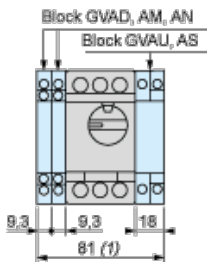

1 Maximum
GV2AK00

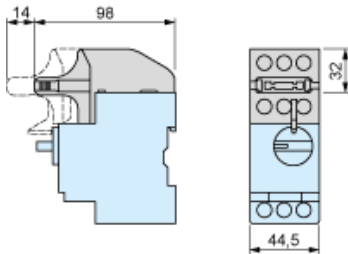

Mounting

On rail AM1 DE200, AM1 ED200 (35 x 15)

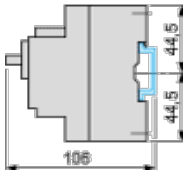

Panel mounted

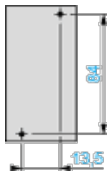

On pre-slotted mounting plate AM1 PA

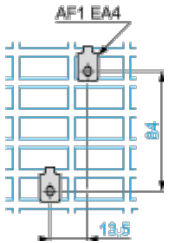

Adapter Plate GK2AF01

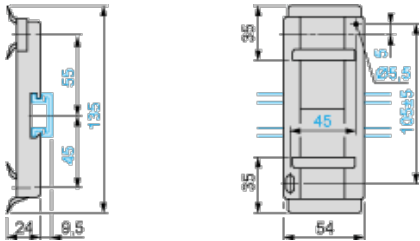

7.5 mm Height Compensation Plate GV1F03

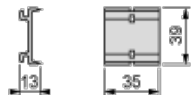

Mounting

Mounting of External Operator GV2APN01, GV2APN02 or GV2APN04 for Motor Circuit Breakers GV2L

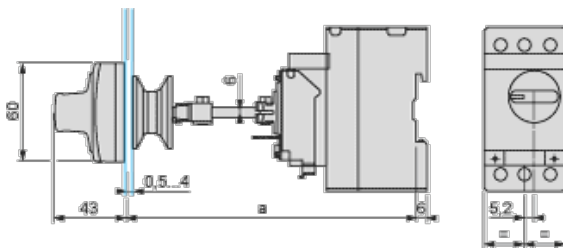

Door cut-out

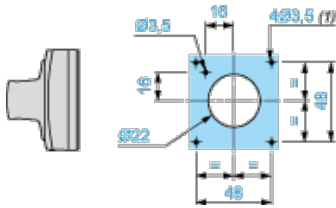

(1) For IP65 only.

Mounting of External Operator GVAPH02 for Motor Circuit Breakers GV2L

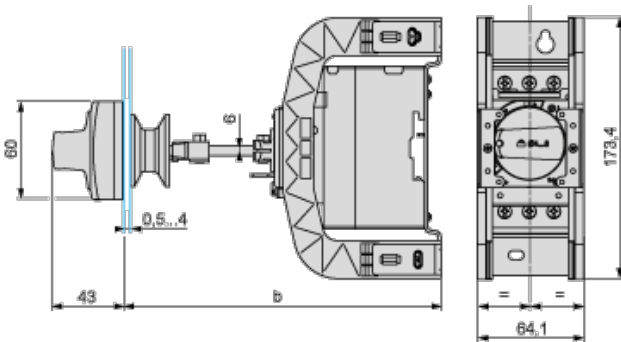

| | b | |
|---------------------------------|---------|---------|
| | Minimum | Maximum |
| GV2 APN.. + GV APH02 | 151 | 250 |
| GV2 APN.. + GV APH02 + GV APK11 | 250 | 445 |

Door cut-out

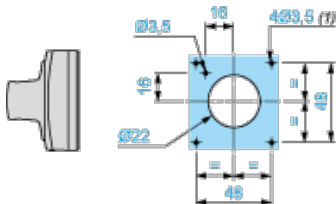

(1) For IP65 only.

GV2L and GV2LE

Sets of busbars GV2G445, GV2G454, GV2G472, with terminal block GV2G05

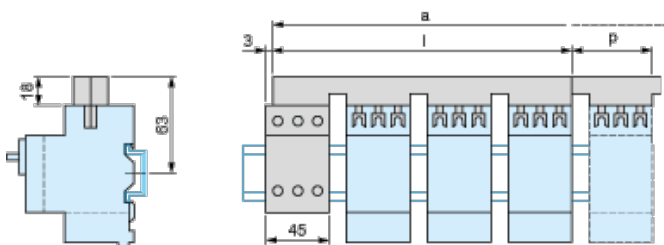

| | l | p |
|---------------------|-----|----|
| GV2G445 (4 x 45 mm) | 179 | 45 |
| GV2G454 (4 x 54 mm) | 206 | 54 |
| GV2G472 (4 x 72 mm) | 260 | 72 |

| Number of tap-offs | a | | | |
|--------------------|---|---|---|---|
| | 5 | 6 | 7 | 8 |
| | | | | |

| | | | | |
|---------|-----|-----|-----|-----|
| GV2G445 | 224 | 269 | 314 | 359 |
| GV2G454 | 260 | 314 | 368 | 422 |
| GV2G472 | 332 | 404 | 476 | 548 |

Sets of Busbars for GV2L and GV2LE

Sets of busbars GV2G... with terminal block GV1G09

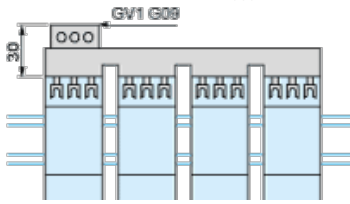

Sets of busbars GV2G245, GV2G254, GV2GR272

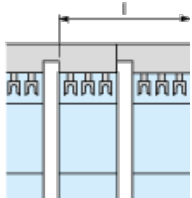

| | I |
|---------------------|-----|
| GV2G245 (2 x 45 mm) | 89 |
| GV2G254 (2 x 54 mm) | 98 |
| GV2G272 (2 x 72 mm) | 116 |

Set of busbars GV2G554

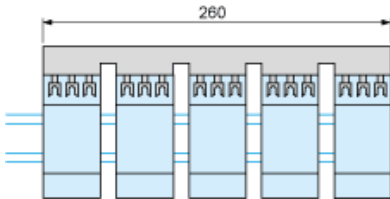

Sets of busbars GV2G345 and GV2G354

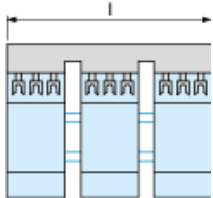

| | I |
|---------------------|-----|
| GV2G345 (3 x 45 mm) | 134 |
| GV2G354 (3 x 54 mm) | 152 |

GV2L••

