

## GV2L20

TeSys GV2 – Prekidači – magnetski – 18 A –  
priključak vijčanim stezaljkama



### Glavno

Range	TeSys
Product name	TeSys GV2
Device short name	GV2L
Product or component type	Circuit breaker
Device application	Motor
Poles description	3P
Network type	AC
Utilisation category	AC-3 conforming to IEC 60947-4-1 Category A conforming to IEC 60947-2
Network frequency	50/60 Hz conforming to IEC 60947-2
Breaking capacity	10 kA Icu at 500 V AC 50/60 Hz conforming to IEC 60947-2 20 kA Icu at 440 V AC 50/60 Hz conforming to IEC 60947-2 100 kA Icu at 230/240 V AC 50/60 Hz conforming to IEC 60947-2 4 kA Icu at 690 V AC 50/60 Hz conforming to IEC 60947-2 50 kA Icu at 400/415 V AC 50/60 Hz conforming to IEC 60947-2
[Ics] rated service short-circuit breaking capacity	100 % at 230/240 V AC 50/60 Hz conforming to IEC 60947-2 100 % at 690 V AC 50/60 Hz conforming to IEC 60947-2 50 % at 400/415 V AC 50/60 Hz conforming to IEC 60947-2 75 % at 440 V AC 50/60 Hz conforming to IEC 60947-2 75 % at 500 V AC 50/60 Hz conforming to IEC 60947-2
Trip unit technology	Magnetic
Magnetic tripping current	223 A

### Komplementarno

Fixing mode	Clipped on 35 mm symmetrical DIN rail Screwed on panel (with 2 x M4 screws)
Operating position	Any position
Motor power kW	15 kW at 690 V AC 50/60 Hz 9 kW at 500 V AC 50/60 Hz 7.5 kW at 400/415 V AC 50/60 Hz
Control type	Rotary knob
[Ue] rated operational voltage	690 V AC 50/60 Hz conforming to IEC 60947-2
[Ui] rated insulation voltage	690 V AC 50/60 Hz conforming to IEC 60947-2
[Uimp] rated impulse withstand voltage	6 kV conforming to IEC 60947-2
Power dissipation per pole	1.8 W
Mechanical durability	100000 cycles
Electrical durability	100000 cycles for AC-3 at 415 V
Operating rate	40 cyc/h
Rated duty	Continuous conforming to IEC 60947-4-1
Connections - terminals	Screw clamp terminals 2 cable(s) 1...6 mm <sup>2</sup> solid Screw clamp terminals 2 cable(s) 1.5...6 mm <sup>2</sup> flexible without cable end Screw clamp terminals 2 cable(s) 1...4 mm <sup>2</sup> flexible with cable end

Informacije dane u ovoj dokumentaciji sadrže opće opisne i/ili tehničke karakteristike o performansama ovdje sadržanih proizvoda.  
Ova dokumentacija nije namijenjena kao zamjena za niti bi se trebala koristiti za određivanje prikladnosti ili pouzdanosti predmetnih proizvoda za konkretne korisničke primjene.  
Svaki takav korisnik ili integrator dužan je provesti odgovarajuću i poplunu analizu rizika, procjenu i ispitivanje proizvoda u odnosu na odgovarajuću specifičnu primjenu ili uporabu istog.  
Niti društvo Schneider Electric, Industries SAS niti bilo koje od njegovih povezanih poduzeća ili podružnica neće preuzeti obvezu ili snositi odgovornost za pogrešku upotrebu ovdje sadržanih informacija.

Tightening torque	1.7 N.m on screw clamp terminals
Mechanical robustness	Shocks 30 Gn conforming to IEC 60068-2-27 Vibrations 5 Gn, 5...150 Hz conforming to IEC 60068-2-6
Suitability for isolation	Yes conforming to IEC 60947-1
Phase failure sensitivity	Yes
Height	89 mm
Width	45 mm
Depth	97 mm
Product weight	0.33 kg

## Okolina

standards	EN 60204 IEC 60947-1 IEC 60947-2 NF C 63-120 NF C 63-650 NF C 79-130 VDE 0113 VDE 0660
product certifications	BV CCC CSA DNV GL LROS (Lloyds register of shipping) RINA
protective treatment	TH
IK degree of protection	IK04
ambient air temperature for operation	-20...60 °C
ambient air temperature for storage	-40...80 °C
fire resistance	960 °C conforming to IEC 60695-2-1
operating altitude	0...2000 m

## Offer Sustainability

Green Premium product	Green Premium product
Compliant - since 0631 - Schneider Electric declaration of conformity	Compliant - since 0631 - Schneider Electric declaration of conformity
Reference contains SVHC above the threshold - go to CaP for more details	Reference contains SVHC above the threshold
Available	Available
Need no specific recycling operations	Need no specific recycling operations

## Contractual warranty

Warranty period	18 months
-----------------	-----------

## Tripping Curves for GV2L or LE Combined with Thermal Overload Relay LRD or LR2K

Average Operating Times at 20 °C Related to Multiples of the Setting Current



- 1 3 poles from cold state
- 2 2 poles from cold state
- 3 3 poles from hot state

**Current Limitation on Short-Circuit for GV2L and GV2LE Only (3-Phase 400/415 V)**

**Dynamic Stress**

$I_{peak} = f(\text{prospective } I_{sc}) \text{ at } 1.05 U_e = 435 \text{ V}$

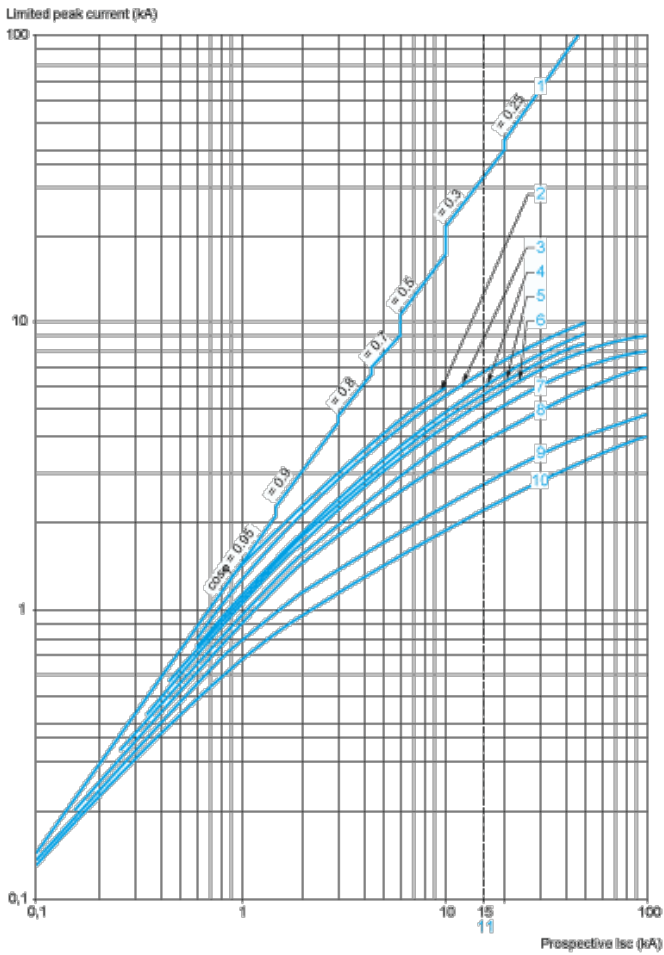

- 1 Maximum peak current
- 2 32 A
- 3 25 A
- 4 18 A
- 5 14 A
- 6 10 A
- 7 6.3 A
- 8 4 A
- 9 2.5 A
- 10 1.6 A
- 11 Limit of rated ultimate breaking capacity on short-circuit of GV2LE (14, 18, 23, and 25 A ratings).

**Current Limitation on Short-Circuit for GV2L and GV2LE + Thermal Overload Relay LRD or LR2K (3-Phase 400/415 V)**

**Dynamic Stress**

$I_{peak} = f(\text{prospective } I_{sc}) \text{ at } 1.05 U_e = 435 \text{ V}$



- 1 Maximum peak current
- 2 32 A
- 3 25 A
- 4 18 A
- 5 14 A
- 6 10 A
- 7 6.3 A
- 8 4 A
- 9 2.5 A
- 10 1.6 A
- 11 Limit of rated ultimate breaking capacity on short-circuit of GV2LE (14, 18, 23, and 25 A ratings).

#### Thermal Limit on Short-Circuit for GV2L Only

#### Thermal Limit in kA<sup>2</sup>s in the Magnetic Operating Zone

Sum of  $I^2dt = f$  (prospective Isc) at 1.05 Ue = 435 V

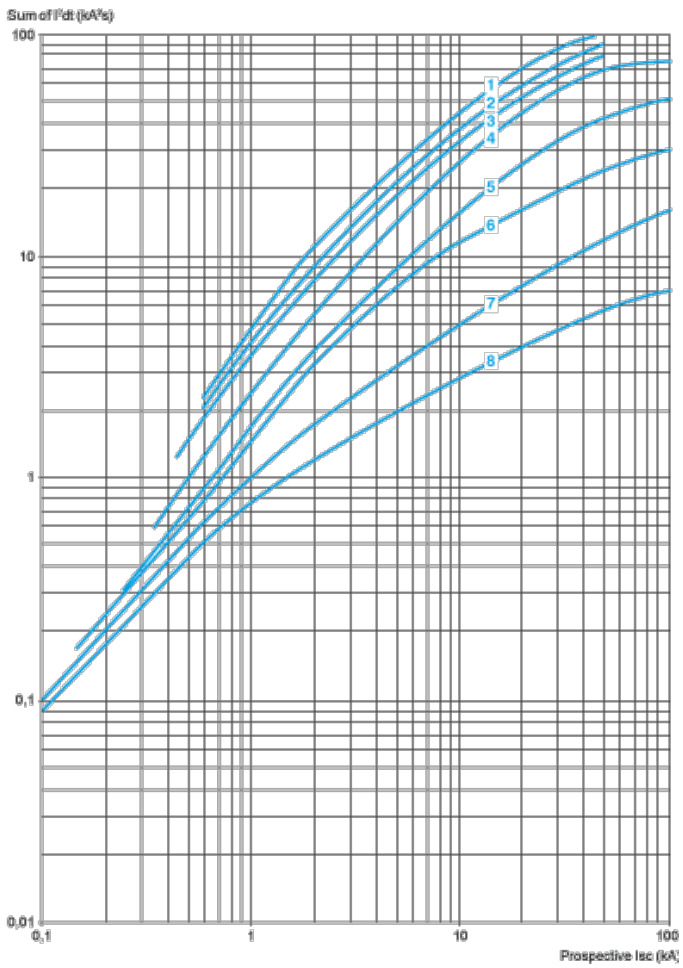

- 1 25 A and 32 A
- 2 18 A
- 3 14 A
- 4 10 A
- 5 6.3 A
- 6 4 A
- 7 2.5 A
- 8 1.6 A

**Thermal Limit on Short-Circuit for GV2L and GV2LE + Thermal Overload Relay LRD or LR2K**

**Thermal Limit in kA²s in the Magnetic Operating Zone**

Sum of  $I^2dt = f$  (prospective Isc) at  $1.05 U_e = 435 V$



- 1 32 A (GV2LE32)
- 2 25 A and 32 A (GV2L32)
- 3 18 A
- 4 14 A
- 5 10 A
- 6 6.3 A
- 7 4 A
- 8 2.5 A
- 9 1.6 A
- 10 Limit of rated ultimate breaking capacity on short-circuit of GV2 LE (14, 18, 23, and 25 A ratings).

**GV2L**

**Dimensions**

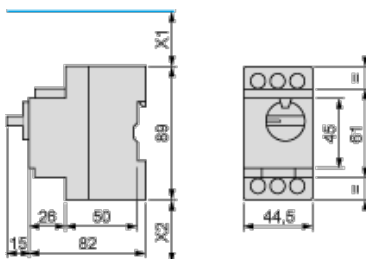

X1 Electrical clearance = 40 mm for  $U_e \leq 415$  V, or 80 mm for  $U_e = 440$  V, or 120 mm for  $U_e = 500$  and  $690$  V.  
 X2 = 40 mm.

**GVAD, AM, AN, AU, AS**

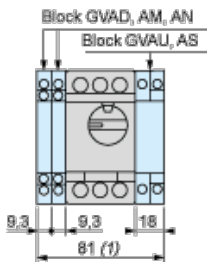

1 Maximum  
GV2AK00

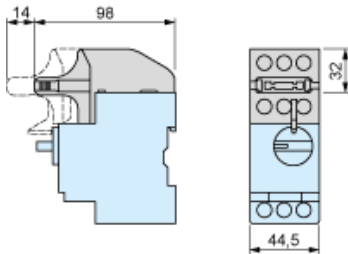

**Mounting**

On rail AM1 DE200, AM1 ED200 (35 x 15)

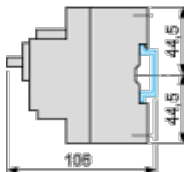

Panel mounted



On pre-slotted mounting plate AM1 PA

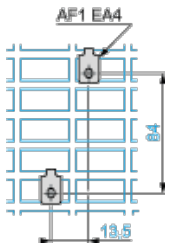

Adapter Plate GK2AF01

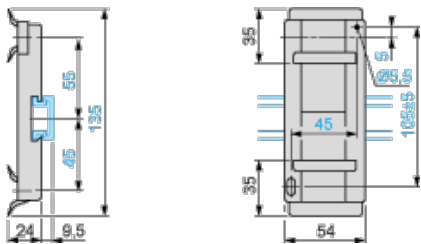

7.5 mm Height Compensation Plate GV1F03



**Mounting**

Mounting of External Operator GV2APN01, GV2APN02 or GV2APN04 for Motor Circuit Breakers GV2L



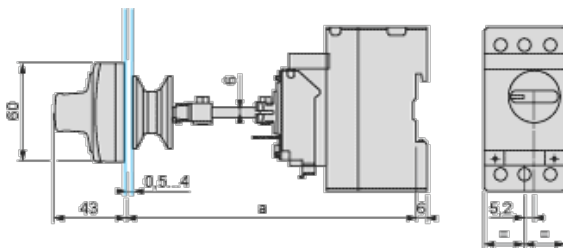

Door cut-out

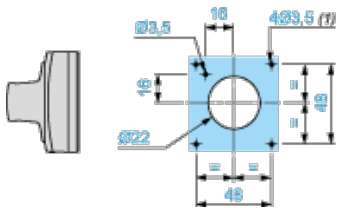

(1) For IP65 only.

### Mounting of External Operator GVAPH02 for Motor Circuit Breakers GV2L

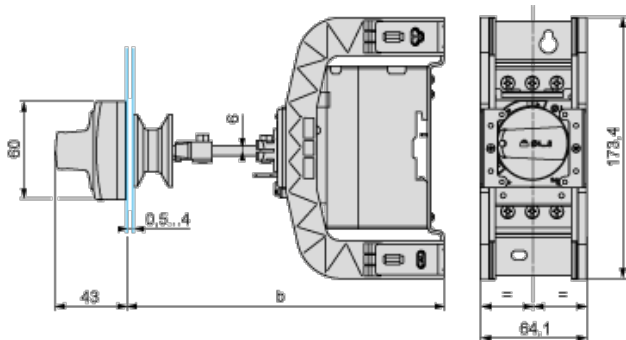

	b	
	Minimum	Maximum
GV2 APN.. + GV APH02	151	250
GV2 APN.. + GV APH02 + GV APK11	250	445

Door cut-out

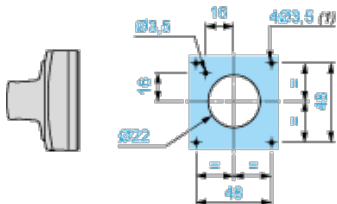

(1) For IP65 only.

### GV2L and GV2LE

Sets of busbars GV2G445, GV2G454, GV2G472, with terminal block GV2G05

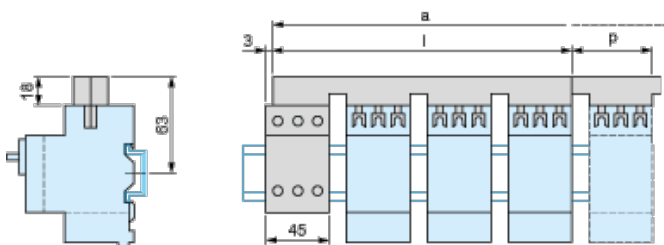

	l	p
GV2G445 (4 x 45 mm)	179	45
GV2G454 (4 x 54 mm)	206	54
GV2G472 (4 x 72 mm)	260	72

Number of tap-offs	a			
	5	6	7	8

GV2G445	224	269	314	359
GV2G454	260	314	368	422
GV2G472	332	404	476	548

### Sets of Busbars for GV2L and GV2LE

Sets of busbars GV2G... with terminal block GV1G09

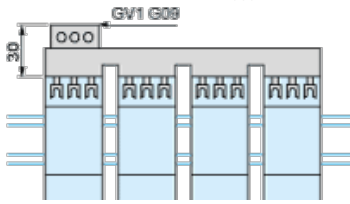

Sets of busbars GV2G245, GV2G254, GV2GR272

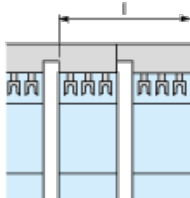

	I
GV2G245 (2 x 45 mm)	89
GV2G254 (2 x 54 mm)	98
GV2G272 (2 x 72 mm)	116

Set of busbars GV2G554

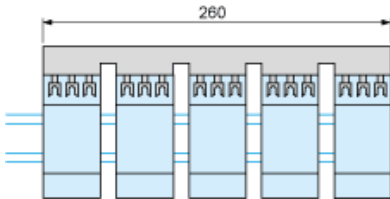

Sets of busbars GV2G345 and GV2G354

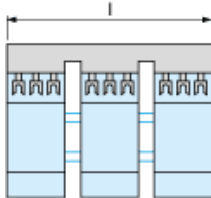

	I
GV2G345 (3 x 45 mm)	134
GV2G354 (3 x 54 mm)	152

GV2L••

