

ATV12H037M2

frekv.pretvarač promj.brzine ATV12–0,37 kW–0,55
ks–200..240 V–1 faza–s hladnjakom



Glavno

Range of product	Altivar 12
Product or component type	Variable speed drive
Product destination	Asynchronous motors
Product specific application	Simple machine
Assembly style	With heat sink
Component name	ATV12
Quantity per set	Set of 1
EMC filter	Integrated
Built-in fan	Without
Network number of phases	1 phase
[Us] rated supply voltage	200...240 V - 15...10 %
Motor power kW	0.37 kW
Motor power hp	0.55 hp
Communication port protocol	Modbus
Line current	5.9 A 200 V 4.9 A 240 V
Speed range	1...20
Transient overtorque	150...170 % of nominal motor torque depending on drive rating and type of motor
Asynchronous motor control profile	Quadratic voltage/frequency ratio Sensorless flux vector control Voltage/frequency ratio (V/f)
IP degree of protection	IP20 without blanking plate on upper part
Noise level	0 dB

Komplementarno

Supply frequency	50/60 Hz +/- 5 %
Connector type	1 RJ45 Modbus on front face
Physical interface	2-wire RS 485 Modbus
Transmission frame	RTU Modbus
Transmission rate	4800 bit/s 9600 bit/s 19200 bit/s 38400 bit/s
Number of addresses	1...247 Modbus
Communication service	Read device identification (43) Read holding registers (03) 29 words Write single register (06) 29 words Write multiple registers (16) 27 words Read/write multiple registers (23) 4/4 words
Prospective line I _{sc}	<= 1 kA
Continuous output current	2.4 A 4 kHz
Maximum transient current	3.6 A 60 s
Speed drive output frequency	0.5...400 Hz
Nominal switching frequency	4 kHz
Switching frequency	2...16 kHz adjustable 4...16 kHz with derating factor
Braking torque	Up to 70 % of nominal motor torque without braking resistor

Informacije dane u ovoj dokumentaciji sadrže opće opise i/ili tehničke karakteristike o performansama ovdje sadržanih proizvoda.
Ova dokumentacija nije namijenjena kao zamjena za niti bi se trebala koristiti za određivanje prikladnosti ili pouzdanosti predmetnih proizvoda za konkretne korisničke primjene.
Svaki takav korisnik ili integrator dužan je provesti odgovarajuću i popunivu analizu rizika, procjenu i ispitivanje proizvoda u odnosu na odgovarajuću specifičnu primjenu ili uporabu istog.
Niti društvo Schneider Electric Industries SAS niti bilo koje od njegovih povezanih podružnica neće preuzeti obvezu ili snositi odgovornost za pogrešnu upotrebu ovdje sadržanih informacija.

Motor slip compensation	Adjustable Preset in factory
Output voltage	200...240 V 3 phases
Electrical connection	Terminal 3.5 mm ² AWG 12 L1, L2, L3, U, V, W, PA, PC
Tightening torque	0.8 N.m
Insulation	Electrical between power and control
Supply	Internal supply for reference potentiometer 5 V DC 4.75...5.25 V 10 mA overload and short-circuit protection Internal supply for logic inputs 24 V DC 20.4...28.8 V 100 mA overload and short-circuit protection
Analogue input number	1
Analogue input type	Configurable current AI1 0...20 mA 250 Ohm Configurable voltage AI1 0...10 V 30 kOhm Configurable voltage AI1 0...5 V 30 kOhm
Discrete input number	4
Discrete input type	Programmable LI1...LI4 24 V 18...30 V
Discrete input logic	Negative logic (sink) > 16 V < 10 V 3.5 kOhm Positive logic (source) 0...< 5 V > 11 V
Sampling duration	20 ms +/- 1 ms logic input 10 ms analogue input
Linearity error	+/- 0.3 % of maximum value analogue input
Analogue output number	1
Analogue output type	Software-configurable voltage AO1 0...10 V 470 Ohm 8 bits Software-configurable current AO1 0...20 mA 800 Ohm 8 bits
Discrete output number	2
Discrete output type	Logic output LO+, LO- Protected relay output R1A, R1B, R1C 1 C/O
Minimum switching current	5 mA 24 V DC logic relay
Maximum switching current	2 A 250 V AC inductive cos phi = 0.4 L/R = 7 ms logic relay 2 A 30 V DC inductive cos phi = 0.4 L/R = 7 ms logic relay 3 A 250 V AC resistive cos phi = 1 L/R = 0 ms logic relay 4 A 30 V DC resistive cos phi = 1 L/R = 0 ms logic relay
Acceleration and deceleration ramps	Linear from 0 to 999.9 s S U
Braking to standstill	By DC injection <= 30 s
Protection type	Line supply overvoltage Line supply undervoltage Overcurrent between output phases and earth Overheating protection Short-circuit between motor phases Against input phase loss in three-phase Thermal motor protection via the drive by continuous calculation of I ² t
Frequency resolution	0.1 Hz display unit Converter A/D, 10 bits analog input
Time constant	20 ms +/- 1 ms for reference change
Marking	CE
Operating position	Vertical +/- 10 degree
Height	143 mm
Width	72 mm
Depth	121.2 mm
Product weight	0.7 kg
Functionality	Basic
Specific application	Commercial equipment
Discrete and process manufacturing	Commercial equipment : mixer Commercial equipment : other application Textile : ironing
Motor starter type	Variable speed drive

Okolina

electromagnetic compatibility	Electrical fast transient/burst immunity test level 4 EN/IEC 61000-4-4 Electrostatic discharge immunity test level 3 EN/IEC 61000-4-2 Radiated radio-frequency electromagnetic field immunity test level 3 EN/IEC 61000-
-------------------------------	--

4-3
 Immunity to conducted disturbances level 3 EN/IEC 61000-4-6
 Surge immunity test level 3 EN/IEC 61000-4-5
 Voltage dips and interruptions immunity test EN/IEC 61000-4-11

electromagnetic emission	Radiated emissions environment 1 category C2 EN/IEC 61800-3 2...16 kHz shielded motor cable Conducted emissions with integrated EMC filter environment 1 category C1 EN/IEC 61800-3 2, 4, 8, 12 and 16 kHz shielded motor cable 5 m Conducted emissions with integrated EMC filter environment 1 category C2 EN/IEC 61800-3 2...12 kHz shielded motor cable 5 m Conducted emissions with integrated EMC filter environment 1 category C2 EN/IEC 61800-3 2, 4 and 16 kHz shielded motor cable 10 m Conducted emissions with additional EMC filter environment 1 category C1 EN/IEC 61800-3 4...12 kHz shielded motor cable 20 m Conducted emissions with additional EMC filter environment 1 category C2 EN/IEC 61800-3 4...12 kHz shielded motor cable 50 m Conducted emissions with additional EMC filter environment 2 category C3 EN/IEC 61800-3 4...12 kHz shielded motor cable 50 m
product certifications	CSA C-Tick GOST NOM UL
vibration resistance	1 gn EN/IEC 60068-2-6 13...200 Hz 1.5 mm peak to peak EN/IEC 60068-2-6 3...13 Hz drive unmounted on symmetrical DIN rail
shock resistance	15 gn EN/IEC 60068-2-27 11 ms
relative humidity	5...95 % without condensation IEC 60068-2-3 5...95 % without dripping water IEC 60068-2-3
ambient air temperature for storage	-25...70 °C
ambient air temperature for operation	40...60 °C with current derating 2.2 % per °C -10...40 °C protective cover from the top of the drive removed
operating altitude	<= 1000 m without derating > 1000...2000 m with current derating 1 % per 100 m

Offer Sustainability

Green Premium product	Green Premium product
Compliant - since 0901 - Schneider Electric declaration of conformity	Compliant - since 0901 - Schneider Electric declaration of conformity
Reference not containing SVHC above the threshold	Reference not containing SVHC above the threshold
Available	Available
Available	Available

Contractual warranty

Warranty period	18 months
-----------------	-----------

Dimensions

Drive without EMC Conformity Kit

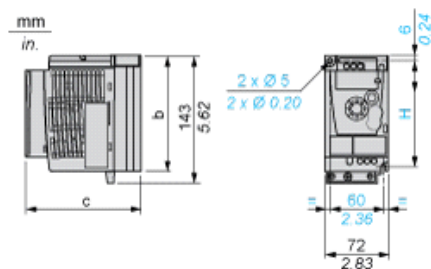

Dimensions in mm

b	c	H
143	121.2	120

Dimensions in in.

b	c	H
5.62	4.77	4.72

5.12	4.77	4.72
------	------	------

Drive with EMC Conformity Kit

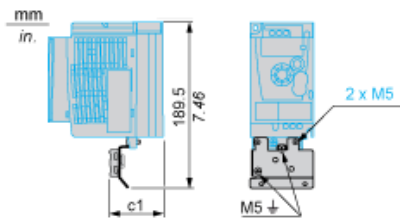

Dimensions in mm

c1
53

Dimensions in in.

c1
2.09

Mounting Recommendations

Clearance for Vertical Mounting

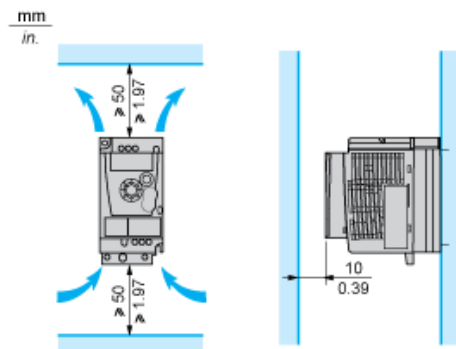

Mounting Type A

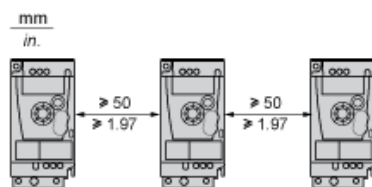

Mounting Type B

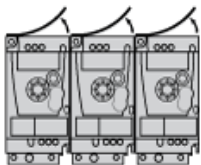

Remove the protective cover from the top of the drive.

Mounting Type C

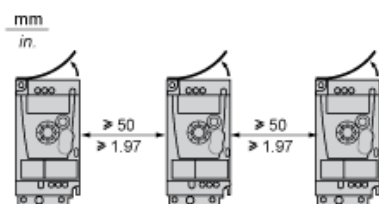

Remove the protective cover from the top of the drive.

Single-Phase Power Supply Wiring Diagram

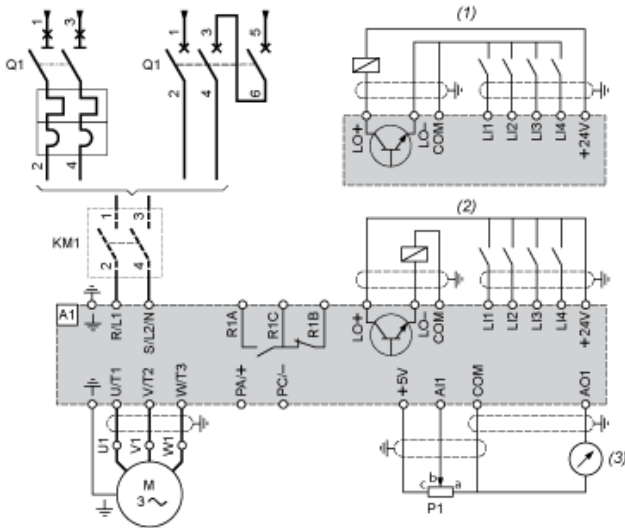

A1 Drive

KM1 Contactor (only if a control circuit is needed)

P1 2.2 kΩ reference potentiometer. This can be replaced by a 10 kΩ potentiometer (maximum).

Q1 Circuit breaker

(1) Negative logic (Sink)

(2) Positive logic (Source) (factory set configuration)

(3) 0...10 V or 0...20 mA

Recommended Schemes

2-Wire Control for Logic I/O with Internal Power Supply

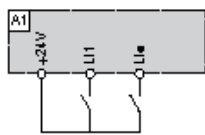

L11 : Forward

L1e : Reverse

A1 : Drive

3-Wire Control for Logic I/O with Internal Power Supply

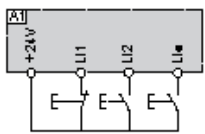

L11 : Stop

L12 : Forward

L1e : Reverse

A1 : Drive

Analog Input Configured for Voltage with Internal Power Supply

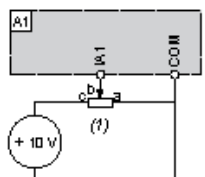

(1) 2.2 kΩ...10 kΩ reference potentiometer

A1 : Drive

Analog Input Configured for Current with Internal Power Supply

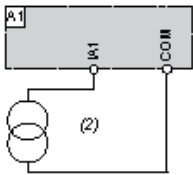

(2) 0-20 mA 4-20 mA supply

A1 : Drive

Connected as Positive Logic (Source) with External 24 vdc Supply

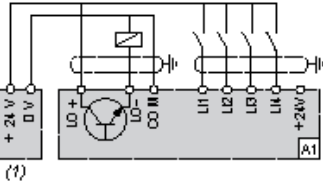

(1) 24 vdc supply

A1 : Drive

Connected as Negative Logic (Sink) with External 24 vdc supply

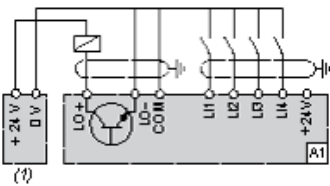

(1) 24 vdc supply

A1 : Drive

Torque Curves

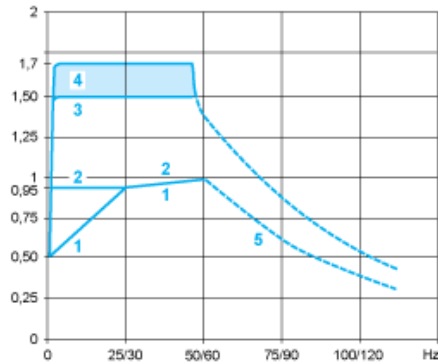

- 1 : Self-cooled motor: continuous useful torque (1)
- 2 : Force-cooled motor: continuous useful torque
- 3 : Transient overtorque for 60 s
- 4 : Transient overtorque for 2 s
- 5 : Torque in overspeed at constant power (2)

- (1) For power ratings ≤ 250 W, derating is 20% instead of 50% at very low frequencies.
- (2) The nominal motor frequency and the maximum output frequency can be adjusted from 0.5 to 400 Hz. The mechanical overspeed capability of the selected motor must be checked with the manufacturer.